









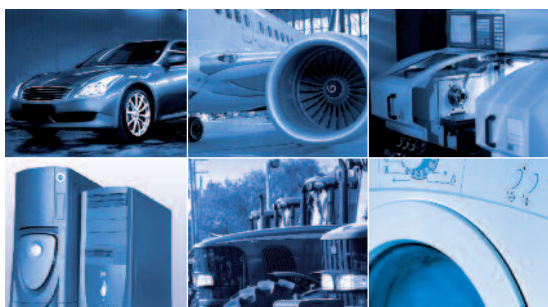

RIVQUICK®

-  Break stem and structural blind rivets
-  Rivets à rupture de tige standards et haute résistance
-  Blindniete und Blindnietwerkzeuge
-  Rivetti a strappo e strutturali
-  Remaches estándar y especiales

BÖLLHOFF







-  Bollhoff the specialist in assembly techniques
-  Böllhoff, le spécialiste des techniques d'assemblage
-  Böllhoff, Ihr Spezialist in der Verbindungs- und Montagetechnik
-  Böllhoff, lo specialista delle tecniche d'assemblaggio
-  Böllhoff, el especialista en técnicas de fijación







-  Bollhoff, your industrial partner in more than 25 countries
-  Böllhoff, votre partenaire industriel implanté dans plus de 25 pays
-  Böllhoff, Ihr verlässlicher Partner in 25 Ländern
-  Böllhoff, il Vostro partner industriale
-  Böllhoff, proveedor industrial internacional







-  Bollhoff, listens to your requests, searching for continuous innovation
-  Böllhoff, à l'écoute de vos besoins, en quête de l'innovation permanente
-  Böllhoff entwickelt für Sie maßgeschneiderte Lösungen mit dem Ziel kontinuierlicher Verbesserung
-  Böllhoff ascolta i vostri bisogni e innova in modo permanente
-  Böllhoff escucha sus demandas e innova permanentemente



-  Bollhoff, service and responsiveness
-  Böllhoff, le savoir-faire logistique et la réactivité
-  Böllhoff, schneller Service
-  Böllhoff, il servizio logistico e la reattività
-  Böllhoff, el servicio, la reactividad



-  Bollhoff, quality at all levels
-  Böllhoff, partout la qualité au plus haut niveau
-  Böllhoff, durchgängig hohe Qualität
-  Böllhoff, la qualità a tutti i livelli
-  Böllhoff, la calidad a todos los niveles





RIVQUICK®

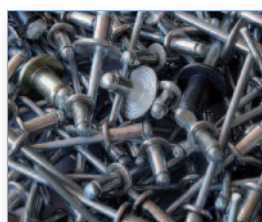

-  RIVQUICK® plus range
-  Gamme RIVQUICK® plus
-  Produktprogramm RIVQUICK® plus
-  Gamma RIVQUICK® plus
-  Gama RIVQUICK® plus





6



-  Standard break stem blind rivets
-  Rivets à rupture de tige standards
-  Standardblindniete
-  Rivetti a strappo standard
-  Remaches de vástago estándar





8



-  Special rivets
-  Rivets spéciaux
-  Spezialblindniete
-  Rivetti per applicazioni speciali
-  Remaches especiales





26



-  High strength and structural rivets
-  Rivets haute résistance et de structure
-  Hochfeste Blindniete
-  Rivetti ad alta resistenza e strutturali
-  Remaches de alta resistencia y estructurales

27



-  Riveting hand tools
-  Appareils de pose manuels
-  Blindnietwerkzeuge
-  Attrezzatura di posa
-  Equipos de colocación

35



Symbol list - Légende - Legende - Legenda - Leyenda

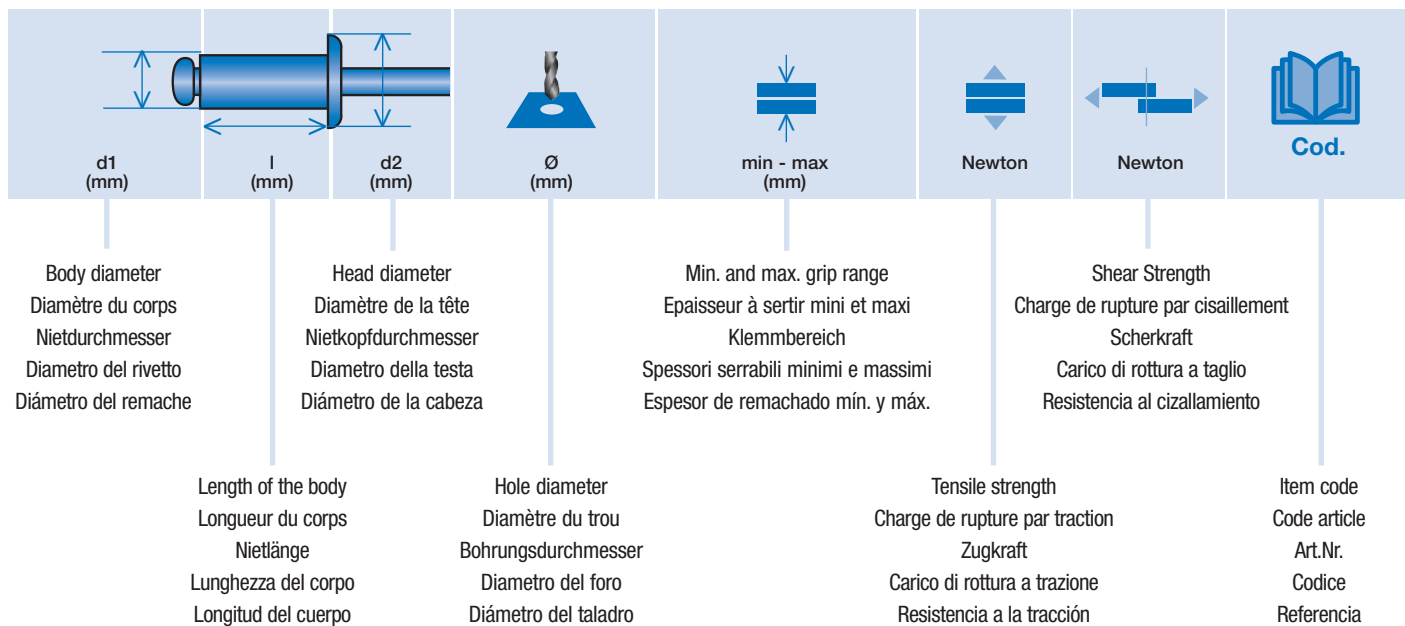

Information - Informations - Information - Informazioni - Información

- 
 - The rivets shown in this list conform to following specifications:
EN ISO 15977 - EN ISO 15978 - EN ISO 15979 - EN ISO 15980 - EN ISO 15981 - EN ISO 15983
 - We reserve the right to modify, without notice, the items shown in our catalogue in order to improve quality.
 - For stock availability, please contact us.

- 
 - Les rivets décrits dans ce document se rapportent aux normes suivantes :
EN ISO 15977 - EN ISO 15978 - EN ISO 15979 - EN ISO 15980 - EN ISO 15981 - EN ISO 15983
 - La société se réserve le droit d'apporter des modifications, sans préavis, à ses produits pour en améliorer la qualité
 - Pour connaître la disponibilité des stocks, nous consulter.

- 
 - Die in dieser Liste beschriebenen Blindnieten beziehen sich auf die folgenden Normen :
EN ISO 15977 - EN ISO 15978 - EN ISO 15979 - EN ISO 15980 - EN ISO 15981 - EN ISO 15983
 - Böllhoff behält sich vor, die in diesem Katalog aufgeführten Produkte zur Qualitätssteigerung ohne vorherige Benachrichtigung anzupassen.
 - Bitte kontaktieren Sie uns bezüglich der Lagerverfügbarkeiten.

- 
 - I rivetti a strappo descritti nel presente listino utilizzano come riferimento le seguenti norme :
EN ISO 15977 - EN ISO 15978 - EN ISO 15979 - EN ISO 15980 - EN ISO 15981 - EN ISO 15983
 - La ditta si riserva la facoltà di apportare modifiche sui prodotti inseriti in questo listino atte a migliorarne la qualità senza preavviso alcuno.
 - Consultateci per conoscere la nostra disponibilità di stock.

- 
 - Los remaches descritos en esta lista responden a las siguientes normas :
EN ISO 15977 - EN ISO 15978 - EN ISO 15979 - EN ISO 15980 - EN ISO 15981 - EN ISO 15983
 - La empresa se reserva el derecho a hacer modificaciones, sin previo aviso, sobre los productos incluidos en este catálogo, con el fin de mejorar la calidad.
 - Para conocer la disponibilidad de stock, consúltenos.

Material - Matière - Materialien - Materiale - Material											Head - Tête - Kopf - Testa - Cabeza			
	Steel		Stainless steel		Aluminium		Aluminium		Stainless steel		pan	countersunk	large flange	extra-large
	alu	steel	steel	steel	stainless steel	stainless steel	alu	alu	alu	stainless steel	pan	countersunk	large flange	extra-large
	alu	acier	acier	acier	inox	inox	alu	alu	alu	inox	plate	fraisée	large	extra-large
	Aluminium	Stahl	Stahl	Stahl	Edelstahl	Edelstahl	Aluminium	Aluminium	Aluminium	Edelstahl	Flachrundkopf	Senkkopf	Großer Kopf	Extra großer Kopf
	allu	acciaio	acciaio	acciaio	inox	inox	allu	allu	allu	inox	tonda	svasata	larga	extra-larga
	alu	acero	acero	acero	inox	inox	alu	alu	alu	inox	alomada	fresada	grande	extra-grande

RIVQUICK^{plus} 2411

	•										•				7
				•							•				7

Standard rivets - Rivets standards - Standardblindniete - Rivetti standard - Remaches estándar

	•										•				8
	•											•			10
	•												•		11
	•													•	12
		•									•				13
		•										•			14
			•								•				15
			•										•		16
							•				•				17
									•		•				18

Peel type rivets - Rivets éclatés - Spreizblindniete - Rivetti a fiore - Remaches de flor

	•										•				19
--	---	--	--	--	--	--	--	--	--	--	---	--	--	--	----

Slotted rivets - Rivets fendus - Presslaschenblindniete - Rivetti 3 ali - Remaches de trébol

							•				•				20
--	--	--	--	--	--	--	---	--	--	--	---	--	--	--	----

Sealed type rivets - Rivets étanches - Becher-Dichtblindniete - Rivetti stagni - Remaches estancos

	•										•				21
				•							•				22

Multigrip - Multiserrage - Mehrbereichsblindniete - Multigrip - Multigrip

	•										•				23
	•												•		23

Coloured rivets - Rivets couleur - Farbige Blindniete - Rivetti colorati - Remaches de colores

	•										•				24
--	---	--	--	--	--	--	--	--	--	--	---	--	--	--	----

Inox A4 - Inox A4 - Edelstahl A4 - Inox A4 - Inox A4

				•							•				25
--	--	--	--	---	--	--	--	--	--	--	---	--	--	--	----



500 pieces per box - 500 pièces par boîte - 500 Stück pro Karton - 500 pezzi per scatola - 500 piezas por caja

RIVQUICK® plus
24H



RIVQUICK® plus range
Gamme RIVQUICK® plus
Produktprogramm RIVQUICK® plus
Gamma RIVQUICK® plus
Gama RIVQUICK® plus

plus

-  **plus range**
Our range of RIVQUICK®plus covers most of all your requirements for steel blind rivets.

 - plus easy**
RIVQUICK®plus speeds up product selection, simplifies ordering and stock control.
 - plus availability**
All products in the RIVQUICK®plus range are available immediately from stock. These items are shipped within 24 hours of your order being placed.
 - plus packaging**
Single pack size for each diameter.

-  **plus gamme**
Notre gamme de RIVQUICK®plus couvre la plupart de vos besoins en rivets aveugles.

 - plus simple**
RIVQUICK®plus facilite la sélection des produits, la commande et la gestion des stocks.
 - plus disponible**
Tous les produits de la gamme RIVQUICK®plus sont disponibles sur stock. Ces articles sont expédiés dans les 24h qui suivent la saisie de votre commande.
 - plus packaging**
Un conditionnement disponible par diamètre.

-  **plus Produktprogramm**
Unser Produktprogramm RIVQUICK®plus deckt den Großteil Ihrer Bedarfe an Blindnieten ab.

 - plus einfach**
RIVQUICK®plus erleichtert die Produktauswahl und die Beschaffung.
 - plus verfügbar**
Alle RIVQUICK®plus Artikel sind ab Lager lieferbar. Diese Elemente werden innerhalb von 24 Stunden ausgeliefert.
 - plus Verpackung**
Es ist eine Verpackungseinheit je Artikel verfügbar.

-  **plus gamma**
Una gamma di RIVQUICK®plus per soddisfare le vostre necessità di rivetti a strappo.

 - plus facile**
RIVQUICK®plus facilita la scelta del prodotto, gli ordini e il controllo in stock.
 - plus disponibile**
Tutti i prodotti della gamma RIVQUICK®Plus sono disponibili in stock. Gli articoli di questa gamma vengono spediti entro le successive 24 ore dal vostro ordine.
 - plus packaging**
Per ogni diametro disponibilità di un lotto di imballo.

-  **plus gama**
Nuestra gama de RIVQUICK®plus cubre casi todas sus necesidades de remaches de vástago.

 - plus simple**
El RIVQUICK®plus facilita la elección de productos, el pedido y la gestión de stocks.
 - plus disponible**
Todos los productos de la gama RIVQUICK®plus están disponibles en stock. Estos artículos se envían en un plazo máximo de 24hrs. una vez confirmada la recepción de su pedido.
 - plus embalaje**
Un tamaño de embalaje disponible por diámetro.

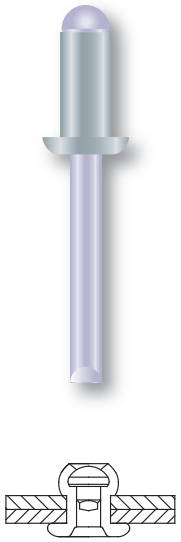

English	Français	Deutsch	Italiano	Español
Pan head	Tête plate	Flachrundkopf	Testa tonda	Cabeza alomada
Aluminium Al Mg 3,5	Aluminium Al Mg 3,5	Aluminium Al Mg 3,5	Alluminio Al Mg 3,5	Aluminio Al Mg 3,5
Steel zinc plated	Acier zingué	Stahl verzinkt	Acciaio zincato	Acero cincado

d1 (mm)	l (mm)	d2 (mm)	Ø (mm)	min - max (mm)	N	N	Cod.		
3,0	6,0	6,0	3,1 - 3,2	1,0 - 3,5	720	620	220 611 30060	■	
	8,0			3,5 - 5,5				900	670
3,2	6,0	6,0	3,3 - 3,4	1,0 - 3,0	1 560	1 050	220 611 40060	■	
	8,0			3,0 - 5,0				220 611 40080	■
	10,0			5,0 - 6,5				220 611 40100	■
	12,0			6,5 - 8,5				220 611 40120	■
4,0	8,0	8,0	4,1 - 4,2	2,5 - 4,0	2 230	1 700	220 611 48080	▲	
	16,0			10,0 - 12,0				220 611 48160	▲
	20,0			14,0 - 16,0				220 611 48200	●
6,0	12,0	12,0	6,1 - 6,2	5,0 - 7,0	3 100	2 550	220 611 60120	●	

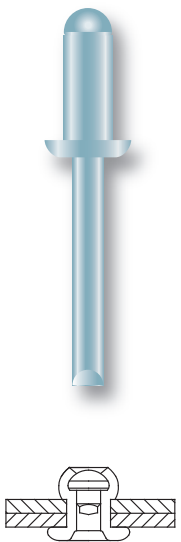

English	Français	Deutsch	Italiano	Español
Pan head	Tête plate	Flachrundkopf	Testa tonda	Cabeza alomada
Stainless steel A2	Inox A2	Edelstahl A2	Inox A2	Inox A2
Stainless steel A2	Inox A2	Edelstahl A2	Inox A2	Inox A2

d1 (mm)	l (mm)	d2 (mm)	Ø (mm)	min - max (mm)	N	N	Cod.		
3,2	8,0	6,0	3,3 - 3,4	3,0 - 5,0	2 500	1 900	220 331 32080	■	
	6,0			1,0 - 2,5				220 331 40060	■
4,0	8,0	8,0	4,1 - 4,2	2,5 - 4,5	3 650	2 900	220 331 40080	■	
	10,0			4,5 - 6,5				220 331 40100	■
	13,0			7,5 - 9,5				220 331 40130	■
	8,0			1,5 - 4,0				220 331 48080	■
4,8	10,0	9,5	4,9 - 5,0	4,0 - 6,0	5 340	4 230	220 331 48100	▲	
	20,0			13,0 - 16,0				220 331 48200	▲

	x 1000	■
	x 500	▲
	x 250	●



Standard break stem blind rivets
 Rivets à rupture de tige standards
 Standardblindniete
 Rivetti a strappo standard
 Remaches de vástago estándar

English	Français	Deutsch	Italiano	Español
Pan head	Tête plate	Flachrundkopf	Testa tonda	Cabeza alomada
Aluminium Al Mg 3,5	Aluminium Al Mg 3,5	Aluminium Al Mg 3,5	Alluminio Al Mg 3,5	Aluminio Al Mg 3,5
Steel zinc plated	Acier zingué	Stahl verzinkt	Acciaio zincato	Acero cincado

d1 (mm)	l (mm)	d2 (mm)	Ø (mm)	min - max (mm)	N	N	Cod.
2,4	5,0	5,0	2,5 - 2,55	0,5 - 2,0	550	400	221 611 24050
	6,0			1,0 - 3,0			221 611 24060
	7,0			2,5 - 4,5			221 611 24070
	8,0			4,0 - 6,0			221 611 24080
	10,0			6,0 - 8,0			221 611 24100
	12,0			8,0 - 10,0			221 611 24120
3,0	5,0	6,5	3,1 - 3,2	0,5 - 2,0	950	600	221 611 30050
	6,0			1,0 - 3,0			221 611 30060
	7,0			2,0 - 4,0			221 611 30070
	8,0			3,0 - 5,0			221 611 30080
	9,0			4,0 - 6,0			221 611 30090
	10,0			5,0 - 7,0			221 611 30100
	11,0			6,0 - 8,0			221 611 30110
	12,0			7,0 - 9,0			221 611 30120
	14,0			9,0 - 11,0			221 611 30140
16,0	11,0 - 13,0	221 611 30160					
18,0	13,0 - 15,0	221 611 30180					
3,2	5,0	6,5	3,3 - 3,4	0,5 - 2,0	1 000	750	221 611 32050
	6,0			1,0 - 3,0			221 611 32060
	7,0			2,0 - 4,0			221 611 32070
	8,0			3,0 - 5,0			221 611 32080
	9,0			4,0 - 6,0			221 611 32090
	10,0			5,0 - 7,0			221 611 32100
	11,0			6,0 - 8,0			221 611 32110
	12,0			7,0 - 9,0			221 611 32120
	14,0			9,0 - 11,0			221 611 32140
	16,0			11,0 - 13,0			221 611 32160
18,0	13,5 - 15,0	221 611 32180					
20,0	14,0 - 17,0	221 611 32200					
4,0	5,0	8,0	4,1 - 4,2	0,5 - 2,0	1 750	1 200	221 611 40050
	6,0			1,0 - 2,5			221 611 40060
	7,0			2,0 - 3,5			221 611 40070
	8,0			3,0 - 4,5			221 611 40080
	9,0			4,0 - 5,5			221 611 40090
	10,0			5,0 - 6,5			221 611 40100
	11,0			6,0 - 7,5			221 611 40110
	12,0			7,0 - 8,5			221 611 40120
	14,0			8,0 - 10,5			221 611 40140
	16,0			10,0 - 12,5			221 611 40160
	18,0			12,0 - 14,5			221 611 40180
	20,0			14,0 - 16,5			221 611 40200
	22,0			16,0 - 18,5			221 611 40220
	24,0			18,0 - 20,5			221 611 40240
	26,0			20,0 - 22,5			221 611 40260
	28,0			22,0 - 24,5			221 611 40280
30,0	24,0 - 26,5	221 611 40300					
35,0	27,0 - 31,5	221 611 40350					

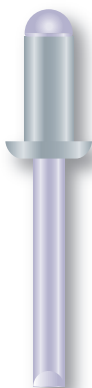

RIVQUICK® Standard rivets - Rivets standards - Standardblindniete - Rivetti standard - Remaches estándar

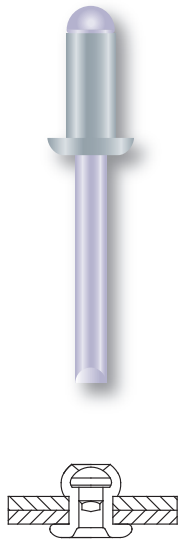

English	Français	Deutsch	Italiano	Español
Pan head	Tête plate	Flachrundkopf	Testa tonda	Cabeza alomada
Aluminium Al Mg 3,5	Aluminium Al Mg 3,5	Aluminium Al Mg 3,5	Alluminio Al Mg 3,5	Aluminio Al Mg 3,5
Steel zinc plated	Acier zingué	Stahl verzinkt	Acciaio zincato	Acero cincado

d1 (mm)	l (mm)	d2 (mm)	Ø (mm)	min - max (mm)	N	N	Cod.
4,8	6,0	9,5	4,9 - 5,0	0,5 - 2,0	2 600	1 850	221 611 48060
	7,0			1,5 - 3,0			221 611 48070
	8,0			2,5 - 4,0			221 611 48080
	9,0			3,5 - 5,0			221 611 48090
	10,0			4,5 - 6,0			221 611 48100
	11,0			5,5 - 7,0			221 611 48110
	12,0			6,5 - 8,0			221 611 48120
	14,0			7,5 - 10,0			221 611 48140
	16,0			9,5 - 12,0			221 611 48160
	18,0			11,5 - 14,0			221 611 48180
	20,0			13,5 - 16,0			221 611 48200
	22,0			15,5 - 18,0			221 611 48220
	24,0			17,5 - 20,0			221 611 48240
	26,0			19,5 - 22,0			221 611 48260
	28,0			21,5 - 24,0			221 611 48280
	30,0			23,5 - 26,0			221 611 48300
35,0	25,5 - 31,0	221 611 48350					
40,0	30,5 - 36,0	221 611 48400					
45,0	35,5 - 40,0	221 611 48450					
50,0	39,5 - 45,0	221 611 48500					
5,0	6,0	9,5	5,1 - 5,2	0,5 - 2,0	2 700	2 000	221 611 50060
	8,0			2,5 - 4,0			221 611 50080
	10,0			4,5 - 6,0			221 611 50100
	12,0			6,5 - 8,0			221 611 50120
	14,0			7,5 - 10,0			221 611 50140
	16,0			9,5 - 12,0			221 611 50160
	18,0			11,5 - 14,0			221 611 50180
	20,0			13,5 - 16,0			221 611 50200
	22,0			15,5 - 18,0			221 611 50220
	24,0			17,5 - 20,0			221 611 50240
26,0	19,5 - 22,0	221 611 50260					
28,0	21,5 - 24,0	221 611 50280					
30,0	23,5 - 26,0	221 611 50300					
6,0	8,0	12,0	6,1 - 6,3	1,0 - 3,0	4 400	2 800	221 611 60080
	10,0			2,5 - 5,0			221 611 60100
	12,0			4,5 - 7,0			221 611 60120
	14,0			5,5 - 9,0			221 611 60140
	16,0			6,5 - 10,0			221 611 60160
	18,0			9,5 - 13,0			221 611 60180
	20,0			11,0 - 14,0			221 611 60200
	22,0			12,5 - 17,0			221 611 60220
	26,0			16,5 - 21,0			221 611 60260
	30,0			20,5 - 25,0			221 611 60300
35,0	24,5 - 30,0	221 611 60350					
40,0	29,5 - 35,0	221 611 60400					
6,4	10,0	13,0	6,5 - 6,7	2,0 - 5,0	4 950	3 200	221 611 64100
	12,0			4,0 - 7,0			221 611 64120
	16,0			6,5 - 10,0			221 611 64160
	18,0			9,5 - 13,0			221 611 64180
	22,0			12,5 - 17,0			221 611 64220
	26,0			16,5 - 21,0			221 611 64260
30,0	20,5 - 25,0	221 611 64300					
35,0	24,5 - 30,0	221 611 64350					
40,0	29,5 - 35,0	221 611 64400					
7,8	15,0	14,0	7,9 - 8,1	4,0 - 9,0	6 500	5 250	221 611 78150
	18,0			9,5 - 13,0			221 611 78180
	22,0			12,5 - 17,0			221 611 78220
	26,0			16,5 - 21,0			221 611 78260
	30,0			20,5 - 25,0			221 611 78300
35,0	24,5 - 30,0	221 611 78350					

RIVQUICK® Standard rivets - Rivets standards - Standardblindniete - Rivetti standard - Remaches estándar

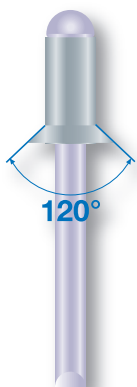

English	Français	Deutsch	Italiano	Español
Countersunk head	Tête fraisée	Senkkopf	Testa svasata	Cabeza fresada
Aluminium Al Mg 3,5	Aluminium Al Mg 3,5	Aluminium Al Mg 3,5	Alluminio Al Mg 3,5	Aluminio Al Mg 3,5
Steel zinc plated	Acier zingué	Stahl verzinkt	Acciaio zincato	Acero cincado

d1 (mm)	l (mm)	d2 (mm)	Ø (mm)	min - max (mm)	N	N	Cod.
2,4	6,0	5,0	2,5 - 2,55	2,0 - 4,0	550	400	221 312 24060
	8,0			4,0 - 6,0			221 312 24080
	10,0			6,0 - 8,0			221 312 24100
3,0	7,0	6,0	3,1 - 3,2	2,0 - 4,0	950	600	221 312 30070
	9,0			4,0 - 6,0			221 312 30090
	11,0			6,0 - 8,0			221 312 30110
3,2	7,0	6,0	3,3 - 3,4	2,0 - 4,0	1 000	750	221 312 32070
	9,0			4,0 - 6,0			221 312 32090
	11,0			6,0 - 8,0			221 312 32110
4,0	7,0	7,5	4,1 - 4,2	2,5 - 4,0	1 750	1 200	221 312 40070
	9,0			3,5 - 6,0			221 312 40090
	11,0			5,5 - 8,0			221 312 40110
	12,0			7,5 - 9,0			221 312 40120
	14,0			8,5 - 11,0			221 312 40140
	16,0			10,5 - 13,0			221 312 40160
	18,0			12,5 - 15,0			221 312 40180
20,0	14,5 - 17,0	221 312 40200					
4,8	7,0	9,0	4,9 - 5,0	2,5 - 4,0	2 600	1 850	221 312 48070
	9,0			3,5 - 5,0			221 312 48090
	11,0			4,5 - 7,0			221 312 48110
	12,0			6,5 - 8,0			221 312 48120
	14,0			7,5 - 10,0			221 312 48140
	16,0			9,5 - 12,0			221 312 48160
	18,0			11,5 - 14,0			221 312 48180
	20,0			13,5 - 16,0			221 312 48200
	26,0			19,5 - 22,0			221 312 48260
	30,0			23,5 - 26,0			221 312 48300

RIVQUICK® Standard rivets - Rivets standards - Standardblindniete - Rivetti standard - Remaches estándar

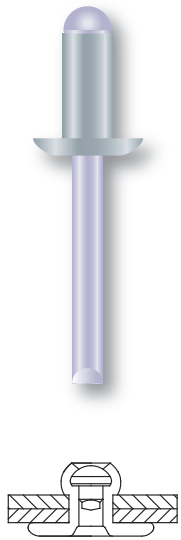

English	Français	Deutsch	Italiano	Español
Large head	Tête large	Großer Kopf	Testa larga	Cabeza grande
Aluminium Al Mg 3,5	Aluminium Al Mg 3,5	Aluminium Al Mg 3,5	Alluminio Al Mg 3,5	Aluminio Al Mg 3,5
Steel zinc plated	Acier zingué	Stahl verzinkt	Acciaio zincato	Acero cincado

d1 (mm)	l (mm)	d2 (mm)	Ø (mm)	min - max (mm)	N	N	Cod.
4,0	8,0	10,0	4,1 - 4,2	2,0 - 4,0	1 750	1 200	221 314 40080
	10,0			5,0 - 6,5			221 314 40100
	12,0			7,0 - 8,5			221 314 40120
	14,0			8,0 - 10,5			221 314 40140
	16,0			10,0 - 12,5			221 314 40160
	20,0			13,0 - 16,5			221 314 40200
4,8	8,0	14,0	4,9 - 5,0	2,5 - 4,0	2 600	1 850	221 314 48080
	10,0			4,5 - 6,0			221 314 48100
	12,0			5,5 - 8,0			221 314 48120
	14,0			7,5 - 10,0			221 314 48140
	16,0			9,5 - 12,0			221 314 48160
	18,0			11,5 - 14,0			221 314 48180
	20,0			13,5 - 16,0			221 314 48200
	24,0			17,5 - 20,0			221 314 48240
	26,0			19,5 - 22,0			221 314 48260
	30,0			23,5 - 26,0			221 314 48300
	35,0			25,5 - 31,0			221 314 48350
	40,0			29,5 - 36,0			221 314 48400



RIVQUICK® Standard rivets - Rivets standards - Standardblindniete - Rivetti standard - Remaches estándar

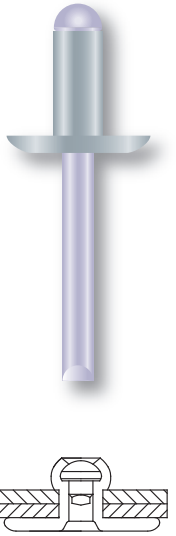

English	Français	Deutsch	Italiano	Español
Extra-large head	Tête extra-large	Extra großer Kopf	Testa extra-larga	Cabeza extra-grande
Aluminium Al Mg 3,5	Aluminium Al Mg 3,5	Aluminium Al Mg 3,5	Alluminio Al Mg 3,5	Aluminio Al Mg 3,5
Steel zinc plated	Acier zingué	Stahl verzinkt	Acciaio zincato	Acero cincado

d1 (mm)	l (mm)	d2 (mm)	Ø (mm)	min - max (mm)	N	N	Cod.
3,2	8,0	10,0	3,3 - 3,4	3,0 - 5,0	1 000	750	221 316 32080
	10,0			5,0 - 7,0			221 316 32100
	12,0			7,0 - 9,0			221 316 32120
	14,0			9,0 - 11,0			221 316 32140
	16,0			11,0 - 13,0			221 316 32160
4,0	8,0	12,0	4,1 - 4,2	2,0 - 4,5	1 750	1 200	221 316 40080
	10,0			5,0 - 6,5			221 316 40100
	12,0			7,0 - 8,5			221 316 40120
	14,0			8,0 - 10,5			221 316 40140
	16,0			10,0 - 12,5			221 316 40160
	20,0			13,0 - 16,5			221 316 40200
4,8	10,0	16,0	4,9 - 5,0	4,5 - 6,0	2 600	1 850	221 316 48100
	12,0			5,5 - 8,0			221 316 48120
	14,0			7,5 - 10,0			221 316 48140
	16,0			9,5 - 12,0			221 316 48160
	18,0			11,5 - 14,0			221 316 48180
	20,0			13,5 - 16,0			221 316 48200
	24,0			15,5 - 18,0			221 316 48240
	26,0			17,5 - 20,0			221 316 48260
	30,0			23,5 - 26,0			221 316 48300
	35,0			25,5 - 31,0			221 316 48350
40,0	30,5 - 36,0	221 316 48400					

RIVQUICK® Standard rivets - Rivets standards - Standardblindniete - Rivetti standard - Remaches estándar

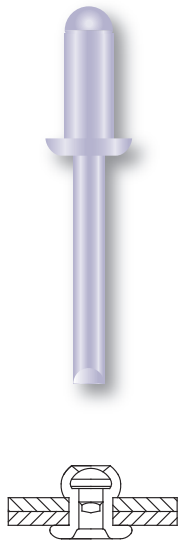

English	Français	Deutsch	Italiano	Español
Pan head	Tête plate	Flachrundkopf	Testa tonda	Cabeza alomada
Steel zinc plated	Acier zingué	Stahl verzinkt	Acciaio zincato	Acero cincado
Steel zinc plated	Acier zingué	Stahl verzinkt	Acciaio zincato	Acero cincado

d1 (mm)	l (mm)	d2 (mm)	Ø (mm)	min - max (mm)	N	N	Cod.
3,0	6,0	6,5	3,1 - 3,2	0,5 - 3,0	1 400	1 050	221 321 30060
	7,0			3,0 - 4,0			221 321 30070
	8,0			4,0 - 5,0			221 321 30080
	9,0			5,0 - 6,0			221 321 30090
	10,0			6,0 - 7,0			221 321 30100
3,2	12,0	6,5	3,3 - 3,4	7,0 - 9,0	1 500	1 100	221 321 30120
	6,0			0,5 - 3,0			221 321 32060
	7,0			3,0 - 4,0			221 321 32070
	8,0			4,0 - 5,0			221 321 32080
	9,0			5,0 - 6,0			221 321 32090
	10,0			6,0 - 7,0			221 321 32100
4,0	11,0	8,0	4,1 - 4,2	7,0 - 8,0	2 500	1 800	221 321 32110
	12,0			8,0 - 9,0			221 321 32120
	16,0			11,0 - 13,0			221 321 32160
	6,0			1,0 - 2,5			221 321 40060
	7,0			2,0 - 3,5			221 321 40070
	8,0			3,0 - 4,5			221 321 40080
	9,0			4,0 - 5,5			221 321 40090
	10,0			5,0 - 6,5			221 321 40100
	11,0			6,0 - 7,5			221 321 40110
	12,0			7,0 - 8,5			221 321 40120
4,8	14,0	9,5	4,9 - 5,0	8,0 - 10,5	3 700	2 900	221 321 40140
	16,0			10,0 - 12,5			221 321 40160
	18,0			12,0 - 14,5			221 321 40180
	20,0			14,0 - 16,5			221 321 40200
	24,0			16,0 - 20,5			221 321 40240
	30,0			20,0 - 26,5			221 321 40300
	6,0			0,5 - 2,0			221 321 48060
	7,0			1,5 - 3,0			221 321 48070
	8,0			2,5 - 4,0			221 321 48080
	9,0			3,5 - 5,0			221 321 48090
	10,0			4,5 - 6,0			221 321 48100
	11,0			5,5 - 7,0			221 321 48110
	12,0			6,5 - 8,0			221 321 48120
	14,0			7,5 - 10,0			221 321 48140
16,0	9,5 - 12,0	221 321 48160					
6,0	18,0	12,0	6,1 - 6,3	11,5 - 14,0	6 000	4 300	221 321 48180
	20,0			13,5 - 16,0			221 321 48200
	24,0			15,5 - 20,0			221 321 48240
	26,0			17,5 - 22,0			221 321 48260
	30,0			19,5 - 26,0			221 321 48300
	8,0			1,0 - 3,0			221 321 60080
	10,0			2,0 - 3,5			221 321 60100
	12,0			3,5 - 7,0			221 321 60120
6,4	15,0	13,0	6,5 - 6,7	6,5 - 10,0	6 500	4 900	221 321 60150
	18,0			9,5 - 13,0			221 321 60180
	22,0			12,5 - 17,0			221 321 60220
	26,0			16,5 - 21,0			221 321 60260
	30,0			20,5 - 25,0			221 321 60300
	8,0			1,0 - 3,0			221 321 64080
10,0	2,0 - 5,0	221 321 64100					
12,0	3,5 - 7,0	221 321 64120					
15,0	6,5 - 10,0	221 321 64150					
18,0	9,5 - 13,0	221 321 64180					
22,0	12,5 - 17,0	221 321 64220					
26,0	16,5 - 21,0	221 321 64260					
30,0	20,5 - 25,0	221 321 64300					

RIVQUICK® Standard rivets - Rivets standards - Standardblindniete - Rivetti standard - Remaches estándar

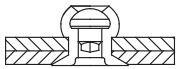
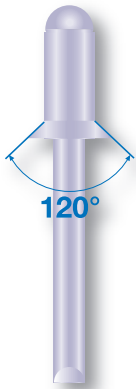

English		Français		Deutsch		Italiano		Español	
Countersunk head		Tête fraisée		Senkkopf		Testa svasata		Cabeza fresada	
Steel zinc plated		Acier zingué		Stahl verzinkt		Acciaio zincato		Acero cincado	
Steel zinc plated		Acier zingué		Stahl verzinkt		Acciaio zincato		Acero cincado	
d1 (mm)	l (mm)	d2 (mm)	Ø (mm)	min - max (mm)	N	N	Cod.		
3,2	8,0	6,0	3,3 - 3,4	3,0 - 5,0	1 500	1 100	221 322 32080		
	10,0			5,0 - 7,0			221 322 32100		
	12,0			7,0 - 9,0			221 322 32120		
4,0	8,0	7,5	4,1 - 4,2	2,5 - 4,5	2 500	1 800	221 322 40080		
	10,0			4,5 - 6,5			221 322 40100		
	12,0			6,5 - 8,5			221 322 40120		
	14,0			8,5 - 10,5			221 322 40140		
4,8	10,0	9,0	4,9 - 5,0	4,0 - 6,0	3 700	2 900	221 322 48100		
	12,0			6,0 - 8,0			221 322 48120		
	14,0			7,0 - 9,0			221 322 48140		
	16,0			7,5 - 11,0			221 322 48160		
	20,0			11,0 - 15,0			221 322 48200		

RIVQUICK® Standard rivets - Rivets standards - Standardblindniete - Rivetti standard - Remaches estándar

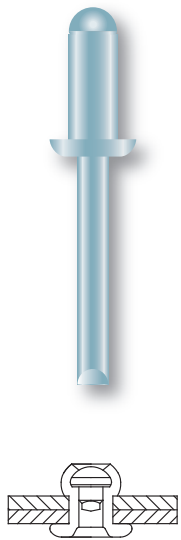

English	Français	Deutsch	Italiano	Español
Pan head	Tête plate	Flachrundkopf	Testa tonda	Cabeza alomada
Stainless steel A2	Inox A2	Edelstahl A2	Inox A2	Inox A2
Stainless steel A2	Inox A2	Edelstahl A2	Inox A2	Inox A2

d1 (mm)	l (mm)	d2 (mm)	Ø (mm)	min - max (mm)	N	N	Cod.
3,0	6,0	6,5	3,1 - 3,2	1,0 - 3,0	2 100	1 900	221 331 30060
	8,0			3,0 - 5,0			221 331 30080
	10,0			5,0 - 7,0			221 331 30100
	12,0			7,0 - 8,5			221 331 30120
3,2	6,0	6,5	3,3 - 3,4	0,5 - 3,0	2 400	1 900	221 331 32060
	8,0			3,0 - 5,0			221 331 32080
	10,0			4,0 - 6,0			221 331 32100
	12,0			6,0 - 8,0			221 331 32120
4,0	6,0	8,0	4,1 - 4,2	1,0 - 3,5	4 000	3 200	221 331 40060
	8,0			2,0 - 4,5			221 331 40080
	10,0			4,0 - 6,5			221 331 40100
	12,0			6,5 - 8,0			221 331 40120
	14,0			7,0 - 9,5			221 331 40140
	16,0			9,0 - 12,0			221 331 40160
4,8	8,0	9,5	4,9 - 5,0	2,5 - 4,0	5 800	4 700	221 331 48080
	10,0			4,0 - 6,0			221 331 48100
	12,0			6,0 - 8,0			221 331 48120
	14,0			7,5 - 10,0			221 331 48140
	16,0			9,5 - 12,0			221 331 48160
	18,0			11,5 - 14,0			221 331 48180
	20,0			13,5 - 16,0			221 331 48200
24,0	15,0 - 19,5	221 331 48240					
6,4	12,0	13,0	6,5 - 6,7	3,5 - 7,0	9 500	7 500	221 331 64120
	15,0			6,5 - 10,0			221 331 64150
	18,0			9,5 - 13,0			221 331 64180
	22,0			12,5 - 17,0			221 331 64220
	26,0			16,5 - 21,0			221 331 64260
	30,0			20,5 - 25,0			221 331 64300



RIVQUICK® Standard rivets - Rivets standards - Standardblindniete - Rivetti standard - Remaches estándar



English	Français	Deutsch	Italiano	Español
Extra-large head	Tête extra-large	Extra großer Kopf	Testa extra-larga	Cabeza extra-grande
Stainless steel A2	Inox A2	Edelstahl A2	Inox A2	Inox A2
Stainless steel A2	Inox A2	Edelstahl A2	Inox A2	Inox A2

4,8	16	4,9 - 5,0	5 800	4 700	221 336 48100
					221 336 48120
					221 336 48140
					221 336 48160
					221 336 48200



RIVQUICK® Standard rivets - Rivets standards - Standardblindniete - Rivetti standard - Remaches estándar



English	Français	Deutsch	Italiano	Español
Pan head	Tête plate	Flachrundkopf	Testa tonda	Cabeza alomada
Aluminium Al Mg 2,5	Aluminium Al Mg 2,5	Aluminium Al Mg 2,5	Alluminio Al Mg 2,5	Aluminio Al Mg 2,5
Aluminium Al Mg 5	Aluminium Al Mg 5	Aluminium Al Mg 5	Alluminio Al Mg 5	Aluminio Al Mg 5

	d1 (mm)	l (mm)	d2 (mm)	Ø (mm)	min - max (mm)	N	N	Cod.
3,2	6,0	6,5	3,3 - 3,4		1,0 - 3,0	850	600	221 371 32060
	8,0				3,0 - 5,0			221 371 32080
	10,0				5,0 - 7,0			221 371 32100
	12,0				7,0 - 9,0			221 371 32120
4,0	6,0	8,0	4,1 - 4,2		1,0 - 2,5	1 200	800	221 371 40060
	8,0				3,0 - 4,5			221 371 40080
	10,0				5,0 - 6,5			221 371 40100
	12,0				7,0 - 8,5			221 371 40120
	14,0				8,0 - 10,5			221 371 40140
	16,0				10,0 - 13,0			221 371 40160
20,0	13,5 - 16,0	221 371 40200						
4,8	8,0	9,5	4,9 - 5,0		2,5 - 4,0	2 100	1 700	221 371 48080
	10,0				4,5 - 6,0			221 371 48100
	12,0				6,5 - 8,0			221 371 48120
	14,0				7,5 - 10,0			221 371 48140
	16,0				9,5 - 12,0			221 371 48160
	18,0				11,5 - 14,0			221 371 48180
20,0	13,5 - 16,5	221 371 48200						



RIVQUICK® Standard rivets - Rivets standards - Standardblindniete - Rivetti standard - Remaches estándar



English		Français		Deutsch		Italiano		Español	
Pan head		Tête plate		Flachrundkopf		Testa tonda		Cabeza alomada	
Aluminium Al Mg 3,5		Aluminium Al Mg 3,5		Aluminium Al Mg 3,5		Alluminio Al Mg 3,5		Aluminio Al Mg 3,5	
Stainless steel A2		Inox A2		Edelstahl A2		Inox A2		Inox A2	
d1 (mm)	l (mm)	d2 (mm)	Ø (mm)	min - max (mm)	N	N	Cod.		
3,0	6,0	6,5	3,1 - 3,2	1,0 - 3,0	950	600	221 351 30060		
	8,0			3,0 - 5,0			221 351 30080		
	10,0			5,0 - 7,0			221 351 30100		
3,2	6,0	6,5	3,3 - 3,4	1,0 - 3,0	1 000	750	221 351 32060		
	8,0			3,0 - 5,0			221 351 32080		
	10,0			5,0 - 7,0			221 351 32100		
	12,0			7,0 - 9,0			221 351 32120		
4,0	6,0	8,0	4,1 - 4,2	1,0 - 2,5	1 750	1 200	221 351 40060		
	8,0			3,0 - 4,5			221 351 40080		
	10,0			5,0 - 6,5			221 351 40100		
	12,0			7,0 - 8,5			221 351 40120		
	14,0			8,0 - 10,5			221 351 40140		
	16,0			10,0 - 12,5			221 351 40160		
4,8	20,0	9,5	4,9 - 5,0	14,0 - 16,5	2 600	1 850	221 351 40200		
	6,0			0,5 - 2,0			221 351 48060		
	8,0			2,5 - 4,0			221 351 48080		
	10,0			4,5 - 6,0			221 351 48100		
	12,0			6,5 - 8,0			221 351 48120		
	14,0			7,5 - 10,0			221 351 48140		
	16,0			9,5 - 12,0			221 351 48160		
	18,0			11,5 - 14,0			221 351 48180		
	20,0			13,5 - 16,0			221 351 48200		
26,0	19,5 - 22,0	221 351 48260							
30,0	23,5 - 26,0	221 351 48300							

RIVQUICK® Peel type rivets - Rivets éclatés - Spreizblindniete - Rivetti a fiore - Remaches de flor

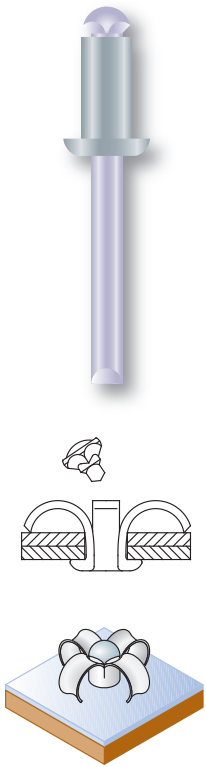

English	Français	Deutsch	Italiano	Español
Pan head	Tête plate	Flachrundkopf	Testa tonda	Cabeza alomada
Aluminium Al Mg 3,5	Aluminium Al Mg 3,5	Aluminium Al Mg 3,5	Alluminio Al Mg 3,5	Aluminio Al Mg 3,5
Steel zinc plated	Acier zingué	Stahl verzinkt	Acciaio zincato	Acero cincado

	d1 (mm)	l (mm)	d2 (mm)	 Ø (mm)	 min - max (mm)	 N	 N	 Cod.
4,0	12,0	8,0	4,1 - 4,2		3,0 - 6,0	1 500	1 250	221 413 40120
	16,0				5,5 - 10,0			221 413 40160
	20,0				9,5 - 14,0			221 413 40200
	24,0				13,5 - 18,0			221 413 40240
4,8	12,0	9,5	4,9 - 5,0		3,0 - 7,0	2 000	1 900	221 413 48120
	14,0				4,0 - 8,0			221 413 48140
	16,0				4,5 - 10,0			221 413 48160
	20,0				9,5 - 14,0			221 413 48200
	24,0				13,5 - 18,0			221 413 48240
	30,0				17,5 - 22,0			221 413 48300
	35,0				21,5 - 27,0			221 413 48350
	40,0				26,5 - 32,0			221 413 48400
	45,0				31,5 - 37,0			221 413 48450
	50,0				36,5 - 42,0			221 413 48500



RIVQUICK® Slotted rivets - Rivets fendus - Presslaschenblindniete - Rivetti 3 ali - Remaches de trébol



English	Français	Deutsch	Italiano	Español
Pan head	Tête plate	Flachrundkopf	Testa tonda	Cabeza alomada
Aluminium Al Mg 2,5	Aluminium Al Mg 2,5	Aluminium Al Mg 2,5	Alluminio Al Mg 2,5	Aluminio Al Mg 2,5
Aluminium Al Mg 5	Aluminium Al Mg 5	Aluminium Al Mg 5	Alluminio Al Mg 5	Aluminio Al Mg 5

4,0	4,1 - 4,4	1,0 - 5,0	800	700	221 478 40160
		3,0 - 8,0			221 478 40200
		5,0 - 11,0			221 478 40250
4,8	5,1 - 5,4	1,0 - 3,0	1 600	1 100	221 478 48160
		3,0 - 8,0			221 478 48200
		5,0 - 11,0			221 478 48250

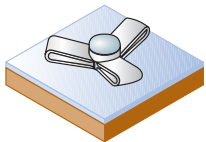
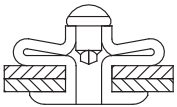

RIVQUICK® Sealed type rivets - Rivets étanches - Becher-Dichtblindniete - Rivetti stagni - Remaches estancos

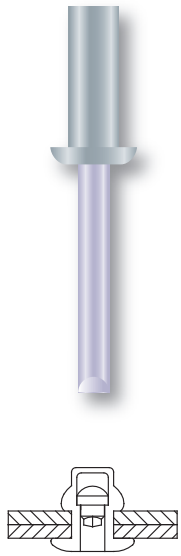

English	Français	Deutsch	Italiano	Español
Pan head	Tête plate	Flachrundkopf	Testa tonda	Cabeza alomada
Aluminium Al Mg 3,5	Aluminium Al Mg 3,5	Aluminium Al Mg 3,5	Alluminio Al Mg 3,5	Aluminio Al Mg 3,5
Steel polished	Acier poli	Stahl verzinkt	Acciaio zincato	Acero cincado

d1 (mm)	l (mm)	d2 (mm)	Ø (mm)	min - max (mm)	N	N	Cod.
3,2	8,0	6,5	3,3 - 3,4	1,5 - 3,0	1150	900	221 411 32080
	9,5			3,0 - 5,5			221 411 32095
	10,7			4,5 - 6,0			221 411 32110
	11,5			6,0 - 7,5			221 411 32115
	12,7			7,0 - 9,0			221 411 32130
4,0	8,0	8,0	4,1 - 4,2	1,0 - 3,0	2 200	1 500	221 411 40080
	10,0			3,0 - 5,0			221 411 40100
	11,5			5,0 - 6,5			221 411 40115
	13,0			6,5 - 8,5			221 411 40130
	14,5			8,0 - 10,5			221 411 40145
4,8	9,5	9,5	4,9 - 5,0	3,0 - 5,0	2 750	2 200	221 411 48095
	11,0			5,0 - 7,0			221 411 48110
	12,5			6,0 - 8,0			221 411 48125
	15,5			8,5 - 11,0			221 411 48155
	18,0			10,5 - 13,0			221 411 48180
22,0	13,0 - 16,0	221 411 48220					



RIVQUICK® Sealed type rivets - Rivets étanches - Becher-Dichtblindniete - Rivetti stagni - Remaches estancos



English	Français	Deutsch	Italiano	Español
Pan head	Tête plate	Flachrundkopf	Testa tonda	Cabeza alomada
Stainless steel A2	Inox A2	Edelstahl A2	Inox A2	Inox A2
Stainless steel A2	Inox A2	Edelstahl A2	Inox A2	Inox A2

d1 (mm)	l (mm)	d2 (mm)	Ø (mm)	min - max (mm)	N	N	Cod.
3,2	8,0	6,5	3,3 - 3,4	1,0 - 3,0	2 200	2 000	221 431 32080
	9,5			3,0 - 5,0			221 431 32095
	12			5,0 - 6,5			221 431 32120
4,0	8,0	8,0	4,1 - 4,2	1,0 - 3,0	3 400	3 300	221 431 40080
	9,5			3,0 - 5,0			221 431 40095
	12,0			5,0 - 6,5			221 431 40120
	16,0			6,5 - 10,5			221 431 40160
4,8	9,5	9,5	4,9 - 5,0	3,0 - 5,0	5 200	4 200	221 431 48095
	12,0			5,0 - 6,5			221 431 48120

RIVQUICK® varigrip Multigrip - Multiserrage - Mehrbereichsblindniete - Multigrip - Multigrip

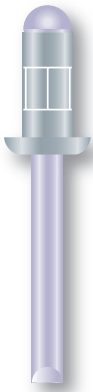

English	Français	Deutsch	Italiano	Español
Pan head	Tête plate	Flachrundkopf	Testa tonda	Cabeza alomada
Aluminium Al Mg 3,5	Aluminium Al Mg 3,5	Aluminium Al Mg 3,5	Alluminio Al Mg 3,5	Aluminio Al Mg 3,5
Steel zinc plated	Acier zingué	Stahl verzinkt	Acciaio zincato	Acero cincado

d1 (mm)	l (mm)	d2 (mm)	Ø (mm)	min - max (mm)	N	N	Cod.
3,2	8,0	6,5	3,3 - 3,4	1,0 - 5,5	900	650	221 211 32080
	9,5			3,0 - 6,5			221 211 32095
	11,5			4,5 - 8,0			221 211 32115
4,0	10,0	8,0	4,1 - 4,2	1,5 - 6,5	1 550	950	221 211 40100
	13,0			4,5 - 9,5			221 211 40130
	17,0			8,0 - 13,0			221 211 40170
4,8	11,0	9,5	4,9 - 5,0	1,0 - 6,5	2 200	1 700	221 211 48110
	15,0			5,0 - 10,5			221 211 48150
	17,0			6,0 - 12,5			221 211 48170
	25,0			12,5 - 20,0			221 211 48250

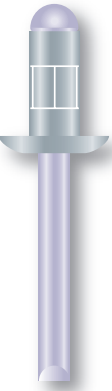

English	Français	Deutsch	Italiano	Español
Large head	Tête large	Großer Kopf	Testa larga	Cabeza grande
Aluminium Al Mg 3,5	Aluminium Al Mg 3,5	Aluminium Al Mg 3,5	Alluminio Al Mg 3,5	Aluminio Al Mg 3,5
Steel zinc plated	Acier zingué	Stahl verzinkt	Acciaio zincato	Acero cincado

d1 (mm)	l (mm)	d2 (mm)	Ø (mm)	min - max (mm)	N	N	Cod.
4,8	10,0	16,0	4,9 - 5,0	1,0 - 6,0	2 200	1 700	221 216 48100
	16,0			6,0 - 12,0			221 216 48160
	25,0			13,0 - 20,0			221 216 48250

RIVQUICK® Coloured rivets - Rivets couleur - Farbige Blindniete - Rivetti colorati - Remaches de colores



English	Français	Deutsch	Italiano	Español						
Pan head	Tête plate	Flachrundkopf	Testa tonda	Cabeza alomada						
Aluminium Al Mg 3,5	Aluminium Al Mg 3,5	Aluminium Al Mg 3,5	Alluminio Al Mg 3,5	Aluminio Al Mg 3,5						
Steel zinc plated	Acier zingué	Stahl verzinkt	Acciaio zincato	Acero cincado						
						RAL	9010	9005	8017	
3,0	6,0	6,5	3,1 - 3,2	1,0 - 3,0	950	600	221 611	30064	30063	30062
	7,0			2,0 - 4,0			221 611	30074	30073	30072
	8,0			3,0 - 5,0			221 611	30084	30083	30082
	9,0			4,0 - 6,0			221 611	30094	30093	30092
	10,0			5,0 - 7,0			221 611	30104	30103	30102
	11,0			6,0 - 8,0			221 611	30114	30113	30112
3,2	6,0	6,5	3,3 - 3,4	1,0 - 3,0	1 000	750	221 611	32064	32063	32062
	7,0			2,0 - 4,0			221 611	32074	32073	32072
	8,0			3,0 - 5,0			221 611	32084	32083	32082
	9,0			4,0 - 6,0			221 611	32094	32093	32092
	10,0			5,0 - 7,0			221 611	32104	32103	32102
	11,0			6,0 - 8,0			221 611	32114	32113	32112
4,0	7,0	8,0	4,1 - 4,2	2,0 - 3,5	1 750	1 200	221 611	40074	40073	40072
	8,0			3,0 - 4,5			221 611	40084	40083	40082
	9,0			4,0 - 5,5			221 611	40094	40093	40092
	10,0			5,0 - 6,5			221 611	40104	40103	40102
	11,0			6,0 - 7,5			221 611	40114	40113	40112
	12,0			7,0 - 8,5			221 611	40124	40123	40122
	14,0			8,0 - 10,5			221 611	40144	40143	40142
	16,0			10,0 - 12,5			221 611	40164	40163	40162
	18,0			12,0 - 14,5			221 611	40184	40183	40182
4,8	7,0	9,5	4,9 - 5,0	1,5 - 3,0	2 600	1 850	221 611	48074	48073	48072
	8,0			2,5 - 4,0			221 611	48084	48083	48082
	9,0			3,5 - 5,0			221 611	48094	48093	48092
	10,0			4,5 - 6,0			221 611	48104	48103	48102
	11,0			5,5 - 7,0			221 611	48114	48113	48112
	12,0			6,5 - 8,0			221 611	48124	48123	48122
	14,0			7,5 - 10,0			221 611	48144	48143	48142
16,0	9,5 - 12,0	221 611	48164	48163	48162					

- We can provide rivets with standard RAL or custom colours. For prices and minimum quantity: contact us.
- Les rivets peuvent être livrés dans toutes les couleurs RAL ou sur échantillon. Prix et quantité minimum : nous consulter.
- Gerne senden wir Ihnen Muster zu. Blindniete sind in vielen RAL-Farben erhältlich. Preise und Mindestbestellmengen auf Anfrage.
- Forniamo rivetti in tutte le colorazioni RAL o su campione. Per prezzi e quantità minime contattateci.
- Los remaches pueden suministrarse en todos los colores RAL o muestras. Para precios y cantidades mínimas, consúltenos.

RIVQUICK® *Stainless steel A4 - Inox A4 - Edelstahl A4 - Inox A4 - Inox A4*

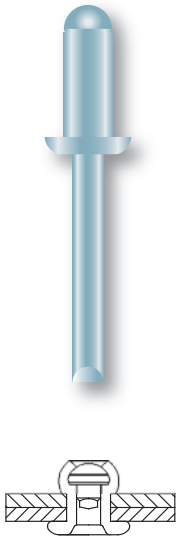

English	Français	Deutsch	Italiano	Español
Pan head	Tête plate	Flachrundkopf	Testa tonda	Cabeza alomada
Stainless steel A4	Inox A4	Edelstahl A4	Inox A4	Inox A4
Stainless steel A4	Inox A4	Edelstahl A4	Inox A4	Inox A4

d1 (mm)	l (mm)	d2 (mm)	Ø (mm)	min - max (mm)	N	N	Cod.
3,2	6,0			0,5 - 3,0			221 381 32060
	8,0	6,5	3,3 - 3,4	3,0 - 5,0	2 600	2 200	221 381 32080
	10,0			4,0 - 6,0			221 381 32100
4,0	8,0			2,0 - 4,5			221 381 40080
	10,0	8,0	4,1 - 4,2	4,0 - 6,5	4 100	3 300	221 381 40100
	12,0			6,5 - 8,0			221 381 40120
	14,0			7,0 - 9,5			221 381 40140
4,8	8,0			2,5 - 4,0			221 381 48080
	10,0	9,5	4,9 - 5,0	4,0 - 6,0	6 000	4 800	221 381 48100
	12,0			6,0 - 8,0			221 381 48120
	14,0			7,5 - 10,0			221 381 48140





Special rivets
Rivets spéciaux
Spezialblindniete
Rivetti per applicazioni speciali
Remaches especiales



Our R&D department, located in our plant in Chambéry (France), develops solutions engineered to your application.



Notre bureau d'étude, situé dans notre usine de Chambéry, conçoit et développe des solutions spécifiques adaptées à votre cahier des charges.



Unsere Entwicklungsabteilung am Produktionsstandort in Chambéry (Frankreich) erarbeitet individuelle Produktlösungen für Ihre Anwendungen.



I nostri uffici Ricerca e Sviluppo situati a Chambéry (Francia) sviluppano soluzioni specifiche per le vostre richieste.



Nuestro departamento de I+D, situado en nuestras fábricas de Chambéry (Francia), desarrolla soluciones adaptadas a sus necesidades específicas.





High strength and structural rivets
 Rivets haute résistance et de structure
 Hochfeste Blindniete
 Rivetti ad alta resistenza e strutturali
 Remaches de alta resistencia y estructurales

Material - Matière - Materialien - Materiale - Material						Head - Tête - Kopf - Testa - Cabeza		
steel		stainless steel		alu		pan	countersunk	
	steel	steel	stainless steel	stainless steel	alu	alu	pan	countersunk
	acier	acier	inox	inox	alu	alu	plate	fraisée
	Stahl	Stahl	Edelstahl	Edelstahl	Aluminium	Aluminium	Flachrundkopf	Senkkopf
	acciaio	acciaio	inox	inox	allu	allu	tonda	svasata
	acero	acero	inox	inox	alu	alu	alomada	fresada

RIVQUICK® varibulb

High strength - Haute résistance - Hochfeste Blindniete - Alta resistenza - Alta resistencia

	•				•		29
		•			•		29

RIVQUICK® varibolt

Structural - Structure - Hochfeste Blindniete - Strutturali - Estructurales

	•				•		31
	•					•	31
				•	•		31
		•				•	32
		•					32

RIVQUICK® varilock

Structural - Structure - Hochfeste Blindniete - Strutturali - Estructurales

	•				•		34
--	---	--	--	--	---	--	----





These rivets optimize security and vibration resistance of the assembly.
The pre-determined mandrel breakage point and retention within the rivet body provides very high shear resistance.
The specific deformation, obtained at the moment of riveting, and the distribution of the joining forces, allow riveting of thin sheet materials



Ces rivets garantissent des assemblages sûrs et insensibles aux vibrations.
La rupture décalée et le verrouillage des tiges assurent une résistance élevée au cisaillement.
La déformation spécifique obtenue lors du sertissage et la répartition des forces d'accostage qui en résulte permettent la pose sur des pièces de faibles épaisseurs.



Diese Blindniete gewährleisten eine feste und vibrations sichere Montage.
Durch die Sollbruchstelle des Dorns und den Halt im Nietkörper ist die Scherfestigkeit überdurchschnittlich hoch.
Die spezifische Verformung, die im Moment der Vernietung entsteht, sowie die Verteilung der Fügekräfte ermöglichen das Vernieten von Dünnschichten.



Questa tipologia di rivetti garantisce un assemblaggio sicuro e resistente alle vibrazioni.
La rottura predeterminata e il bloccaggio dei chiodi assicura resistenza al taglio superiore allo standard.
La deformazione specifica ottenuta al momento del serraggio e la ripartizione delle forze di accostamento permettono la posa su materiali di spessori sottili.



Estos remaches garantizan uniones seguras y resistentes a las vibraciones.
La envoltura de la cabeza de los vástagos después de la colocación asegura una gran resistencia al cizallamiento.
La deformación específica obtenida en la colocación y la repartición de las fuerzas de la unión hacen posible su colocación en piezas de poco espesor.

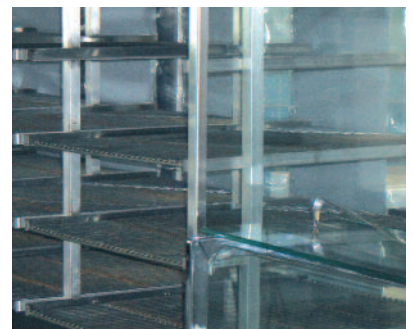
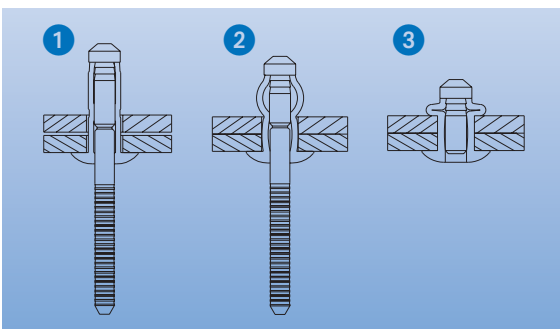

RIVQUICK® varibulb *High strength - Haute résistance - Hochfeste Blindniete - Alta resistenza - Alta resistencia*

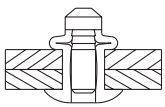

English		Français		Deutsch		Italiano		Español	
Pan head		Tête plate		Flachrundkopf		Testa tonda		Cabeza alomada	
Steel zinc plated		Acier zingué		Stahl verzinkt		Acciaio zincato		Acero cincado	
Steel zinc plated		Acier zingué		Stahl verzinkt		Acciaio zincato		Acero cincado	

d1 (mm)	l (mm)	d2 (mm)	Ø (mm)	min - max (mm)	N	N	Cod.
3,2	11,0	6,5	3,3 - 3,4	1,0 - 3,0	1 250	2 400	221 823 32070
	13,0			3,0 - 5,0			221 823 32090
	15,0			5,0 - 7,0			221 823 32110
4,0	11,0	8,0	4,1 - 4,2	1,0 - 3,0	2 100	3 400	221 823 40070
	13,0			3,0 - 5,0			221 823 40090
	16,0			5,0 - 7,0			221 823 40120
4,8	12,1	9,3	4,9 - 5,1	1,5 - 3,5	3 800	3 300 - 3 600	223 821 48121
	14,6			3,5 - 5,5		3 300 - 4 200	223 821 48146
	17,0			2,0 - 6,0		5 000 - 10 000	223 823 64170
6,4	20,0	12,7	6,6 - 7,0	5,0 - 9,0	7 000		223 823 64200

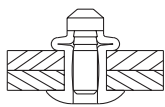
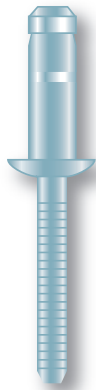

English		Français		Deutsch		Italiano		Español	
Pan head		Tête plate		Flachrundkopf		Testa tonda		Cabeza alomada	
Stainless steel A2		Inox A2		Edelstahl A2		Inox A2		Inox A2	
Stainless steel A2		Inox A2		Edelstahl A2		Inox A2		Inox A2	

d1 (mm)	l (mm)	d2 (mm)	Ø (mm)	min - max (mm)	N	N	Cod.
3,2	11,0	6,5	3,3 - 3,4	1,0 - 3,0	2 650	3 700	221 833 32070
	13,0			2,0 - 4,5			221 833 32090
	15,0			4,5 - 7,0			221 833 32110
4,0	11,0	8,0	4,1 - 4,2	1,0 - 3,0	3 900	5 500	221 833 40070
	13,0			2,0 - 4,0			221 833 40090
	16,0			4,0 - 7,0			221 833 40120
4,8	12,9	9,3	4,9 - 5,1	1,5 - 3,5	5 300	3 900 - 5 000	223 831 48129
	14,6			3,5 - 5,5		223 831 48155	
	17,6			5,5 - 7,5		223 831 48180	
6,4	17,0	12,7	6,6 - 7,0	2,0 - 6,0	8 500	7 500 - 15 000	223 833 64170
	20,0			5,0 - 9,0		223 833 64200	





The wide grip range of these rivets allows fastener rationalisation and with consequent inventory reduction. The shear resistance values obtained with these rivets are very high, giving greater rigidity to the assembled structures.

The clenching action of the rivet allows metal plates to be joined, even where there are significant gaps, along with the possibility of use in laminates of variable thickness.



La large plage de sertissage de ces rivets permet une réduction des stocks de composants et une utilisation sur des épaisseurs variables.

La puissance de l'accostage permet le contact des supports même lors d'espacements importants. L'effort d'accostage est maintenu dans l'assemblage et résiste aux déformations et vibrations des applications.

Le système de mandrin à tête creuse garantit le bon remplissage des trous et de l'étanchéité aux eaux de ruissellement.



Der große Klemmbereich dieser Nieten ermöglicht eine Rationalisierung der Verbindungselemente und somit auch eine Reduzierung der Lagerbestände. Die Scherfestigkeit, die mit diesen Nieten erreicht wird, ist sehr hoch, so dass die montierten Komponenten eine höhere Festigkeit aufweisen. Aufgrund der Klemmkraft des Nieten können Bleche auch bei beträchtlichen Spaltgrößen gefügt werden. Der Niet kann außerdem zum Fügen von Bauteilen unterschiedlicher Dicke verwendet werden.



L'ampia gamma di serraggio di questi rivetti permette una riduzione dello stock dei componenti con la possibilità di impiego su superfici di spessore variabile.

I valori al taglio ottenuti con questi rivetti sono notevolmente superiori alla media, determinando un'elevata rigidità delle strutture assemblate

L'azione del rivetto permette l'accostamento delle lamiere anche in caso di scostamenti delle parti da unire.



Su gran zona de ramachado le permite absorber variaciones de espesores y posibiliza la reducción del número de referencias en el almacén.

Esta característica del remache permite grandes tolerancias de fabricación en la piezas a montar sin reducir las características de la fijación.

La fuerza de colocación se mantiene en la unión, lo que asegura una perfecta resistencia a las deformaciones y vibraciones de las aplicaciones.

El sistema de vástago con cabeza hueca garantiza el relleno total del alojamiento y la estanqueidad al agua o las salpicaduras.

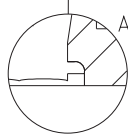
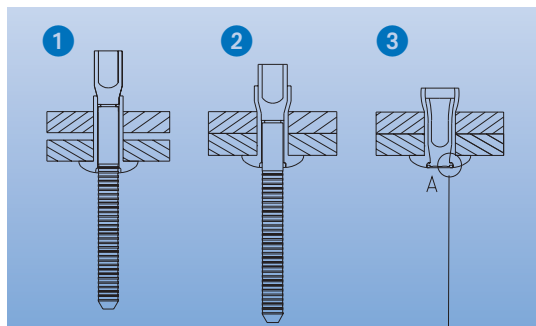

A (5:1) Visual check that stem has been locked during setting (see specific nosepiece on page 39/41)

Verrouillage de la tige visible après pose (voir embouchure à utiliser page 39/41)

Sichtkontrolle der Nietnagelverriegelung während des Setzvorgangs (siehe spezielles Mundstück auf Seite 39/41)

Bloccaggio meccanico del chiodo visibile dopo la posa (vedere nasello da utilizzare a pag 39/41)

Vista del cierre del vástago después de la colocación (ver boquilla de colocación a utilizar, en la pág. 39/41)

RIVQUICK® varibolt *Structural - Structure - Hochfeste Blindniete - Strutturali - Estructurales*



English		Français		Deutsch		Italiano		Español	
Pan head		Tête plate		Flachrundkopf		Testa tonda		Cabeza alomada	
Steel zinc plated		Acier zingué		Stahl verzinkt		Acciaio zincato		Acero cincado	
Steel zinc plated		Acier zingué		Stahl verzinkt		Acciaio zincato		Acero cincado	

d1 (mm)	l (mm)	d2 (mm)	Ø (mm)	min - max (mm)	N	N	Cod.
4,8	20,0	9,5	4,9 - 5,1	1,6 - 6,8	5 000	5 900	223 821 48100
	25,0			1,6 - 11,1			223 821 48140
6,4	24,0	13,2	6,6 - 7,0	2,0 - 9,5	9 500	11 100	223 821 64140
	33,0			2,0 - 15,9			223 821 64190

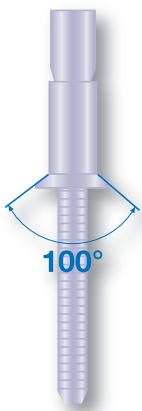
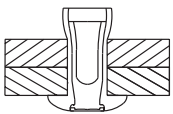

English		Français		Deutsch		Italiano		Español	
Countersunk head		Tête fraisée		Senkkopf		Testa svasata		Cabeza fresada	
Steel zinc plated		Acier zingué		Stahl verzinkt		Acciaio zincato		Acero cincado	
Steel zinc plated		Acier zingué		Stahl verzinkt		Acciaio zincato		Acero cincado	

d1 (mm)	l (mm)	d2 (mm)	Ø (mm)	min - max (mm)	N	N	Cod.
4,8	21,0	8,5	4,8 - 5,2	3,2 - 8,4	5 000	5 900	223 822 48130
	27,0			3,2 - 12,1			223 822 64160



RIVQUICK® varibolt *Structural - Structure - Hochfeste Blindniete - Strutturali - Estructurales*



English	Français	Deutsch	Italiano	Español
Pan head	Tête plate	Flachrundkopf	Testa tonda	Cabeza alomada
Stainless steel A2	Inox A2	Edelstahl A2	Inox A2	Inox A2
Stainless steel A2	Inox A2	Edelstahl A2	Inox A2	Inox A2

d1 (mm)	l (mm)	d2 (mm)	Ø (mm)	min - max (mm)	N	N	Cod.
4,8	20,0	9,5	4,9 - 5,1	1,6 - 6,8	4 800	6 300	223 831 48100
	25,0			1,6 - 11,1			223 831 48140
6,4	24,0	13,2	6,6 - 7,0	2,0 - 9,5	9 500	11 100	223 831 64140
	33,0			2,0 - 15,9			223 831 64190

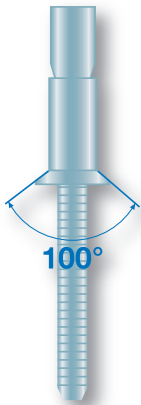
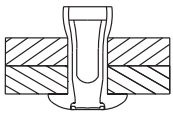

English	Français	Deutsch	Italiano	Español
Countersunk head	Tête fraisée	Senkkopf	Testa svasata	Cabeza fresada
Stainless steel A2	Inox A2	Edelstahl A2	Inox A2	Inox A2
Stainless steel A2	Inox A2	Edelstahl A2	Inox A2	Inox A2

d1 (mm)	l (mm)	d2 (mm)	Ø (mm)	min - max (mm)	N	N	Cod.
6,4	27,0	10,0	6,6 - 7,0	3,2 - 12,1	9 500	11 100	223 832 64160



RIVQUICK® varilock *Structural - Structure - Hochfeste Blindniete - Strutturali - Estructurales*



This range of rivet offers superior shear strength. The convex surface area distributes the setting load over a wider area, to eliminate the possibility of surface damage to thin or soft materials.



Ces rivets de structure sont indiqués pour des applications très fortement sollicitées, notamment à l'arrachement. La surface du bourrelet répartit les forces d'accostage sur une plus grande surface et permet la pose sans dommage sur des pièces de faibles épaisseurs ou sur des matériaux tendres.



Diese Blindniete haben eine hohe Scherfestigkeit. Die konvexe Oberfläche leitet die Setzkräfte in eine vergrößerte Fläche ab, so dass die Oberfläche von dünnen oder weichen Materialien nicht beschädigt wird.



Questa gamma di rivetti strutturali presenta una elevata resistenza allo strappo. La superficie della bombatura ripartisce le forze di accostamento su una più grande superficie e permette la posa senza danneggiamento in caso di spessori deboli o di materiali dolci.





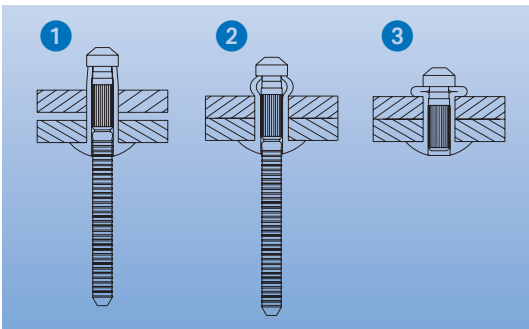



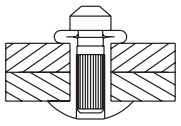
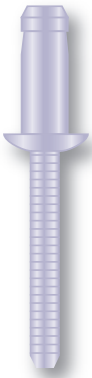



Esta gama de remaches estructurales se utiliza en aplicaciones que requieren una gran resistencia al arrancamiento. La deformación del remache producido por la acción del aparato de colocación reparte las fuerzas de unión sobre una superficie más grande y garantiza una perfecta colocación en piezas de poco espesor o en materiales blandos.



RIVQUICK® varilock *Structural - Structure - Hochfeste Blindniete - Strutturali - Estructurales*



	English	Français	Deutsch	Italiano	Español
	Pan head	Tête plate	Flachrundkopf	Testa tonda	Cabeza alomada
	Steel zinc plated	Acier zingué	Stahl verzinkt	Acciaio zincato	Acero cincado
	Steel zinc plated	Acier zingué	Stahl verzinkt	Acciaio zincato	Acero cincado

								
	d1 (mm)	l (mm)	d2 (mm)	Ø (mm)	min - max (mm)	N	N	Cod.
6,4	15,9	13,4	6,7 - 6,9	2,8 - 4,8	6 000	9 000	223 824 64150	
	15,6			3,4 - 5,3	7 500	11 500	223 824 64156	
	17,9			4,8 - 6,8	6 000	9 000	223 824 64170	
	19,9			6,8 - 8,8	6 000	11 000	223 824 64190	
	21,9			8,8 - 10,8	7 500	12 000	223 824 64210	
	23,0			10,8 - 12,8	7 500	11 500	223 824 64230	



Riveting hand tools
 Appareils de pose manuels
 Blindnietwerkzeuge
 Attrezzatura di posa
 Equipos de colocación



Hand-operated setting tools
 Outils de pose manuels
 Hand-Blindnietwerkzeuge
 Apparecchi di posa manuale
 Aparatos de colocación manuales

36



Hydraulic/pneumatic blind riveting tool
 Appareils de pose oléopneumatiques
 Pneumatisch-hydraulische Blindnietwerkzeuge
 Apparecchi di posa oleopneumatica
 Aparatos de colocación oleoneumáticos

37



Battery operated setting tools
 Outils de pose à batterie
 Akku-Blindnietwerkzeuge
 Apparecchi di posa a batteria
 Remachadoras a batería

40



RIVQUICK® Hand-operated setting tools - Outils de pose manuels - Hand-Blindnietwerkzeuge Apparecchi di posa manuale - Aparatos de colocación manuales

BRS 02 - Plier type setting tool - Pince à main - Hand-Blindnietwerkzeuge - Pinza manuale - Pinza de mano

 Alu - Alu - Alu - Allu - Alu Zinc plated - Acier zingué - Stahl verzinkt Acciaio zincato - Acero cincado Stainless steel - Inox - Edelstahl - Inox - Inox	Ø							
	2,4	3,0	3,2	4,0	4,8	5,0	6,0	6,4
Alu - Alu - Alu - Allu - Alu	☐	☐	☐	☐	☐	☐	☐	☐
Zinc plated - Acier zingué - Stahl verzinkt Acciaio zincato - Acero cincado	☐	☐	☐	☐	☐	☐	☐	☐
Stainless steel - Inox - Edelstahl - Inox - Inox	☐	☐	☐	☐	☐	☐	☐	☐



540 g.



225 020 00000



Kits available - Existe en coffret - Im Koffer erhältlich - Disponibile anche con valigetta - Disponible también en cofre

BRS 10 - Lever type setting tool - Pince à levier - Hand-Blindnietwerkzeuge - Pinza a leva - Pinza de palanca

 Alu - Alu - Alu - Allu - Alu Zinc plated - Acier zingué - Stahl verzinkt Acciaio zincato - Acero cincado Stainless steel - Inox - Edelstahl - Inox - Inox	Ø							
	2,4	3,0	3,2	4,0	4,8	5,0	6,0	6,4
Alu - Alu - Alu - Allu - Alu	☐	☐	☐	☐	☐	☐	☐	☐
Zinc plated - Acier zingué - Stahl verzinkt Acciaio zincato - Acero cincado	☐	☐	☐	☐	☐	☐	☐	☐
Stainless steel - Inox - Edelstahl - Inox - Inox	☐	☐	☐	☐	☐	☐	☐	☐



1900 g.



225 210 00000

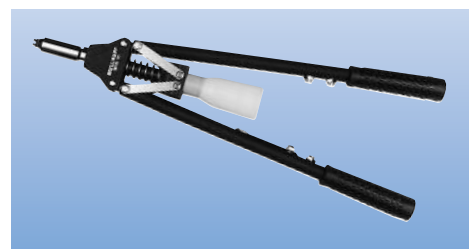

BRS 20 - Extension type setting tool - Pince à extenseur - Hand-Blindnietwerkzeuge - Pinza a estensione - Pinza extensora

 Alu - Alu - Alu - Allu - Alu Zinc plated - Acier zingué - Stahl verzinkt Acciaio zincato - Acero cincado Stainless steel - Inox - Edelstahl - Inox - Inox	Ø							
	2,4	3,0	3,2	4,0	4,8	5,0	6,0	6,4
Alu - Alu - Alu - Allu - Alu	☐	☐	☐	☐	☐	☐	☐	☐
Zinc plated - Acier zingué - Stahl verzinkt Acciaio zincato - Acero cincado	☐	☐	☐	☐	☐	☐	☐	☐
Stainless steel - Inox - Edelstahl - Inox - Inox	☐	☐	☐	☐	☐	☐	☐	☐



2000 g.



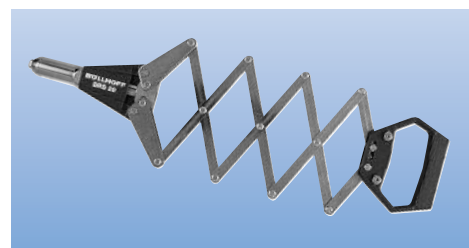

225 220 00000





Riveting Kit BRS 02 - Coffret BRS 02 - Sortimentkoffer BRS 02 - Valigetta BRS 02 - Cofre BRS 02



 BRS 02 plier tool and a selection of aluminium rivets with steel mandrel.

 Avec une pince à main BRS 02 et un assortiment de rivets alu, tige acier, tête plate et tête large.

 BRS 02 Handsetzange und eine Auswahl an Blindnieten aus Aluminium mit Stahldorn.

 Pinza con selezione di rivetti in alluminio con chiodo in acciaio.

 Con una pinza de mano BRS 02 y un surtido de remaches de aluminio, vástago de acero, cabeza alomada y cabeza grande.



V	d1 (mm)	l (mm)	Head - Tête - Kopf - Testa - Cabeza	
				
3	6		☐	
3	8		☐	
4	8		☐	
4	10		☐	
4	12		☐	
4	10			☐



225 020 00501





RIVQUICK® Hydraulic/pneumatic blind riveting tool - Appareils de pose oléopneumatiques
 Pneumatisch-hydraulische Blindnietwerkzeuge - Apparecchi di posa oleopneumatica
 Aparatos de colocación oleoneumáticos

	RIVQUICK® P1000	RIVQUICK® P2000	RIVQUICK® P3000
 Kg	1 250 g	1 650 g	1800 g
Setting force - Traction - Setzkraft Trazione - Tracción	7 300 N	12 500 N	16 000 N
Tool stroke - Course - Gerätehub Corsa - Recorrido	17 mm	21 mm	25 mm
 bars	5 - 7 bars	5 - 7 bars	5 - 7 bars

- 1/4 turn removable stem collector - Bol récupérateur de tiges démontable 1/4 de tour - Abnehmbarer Nietdorn-Auffangbehälter - Serbatoio recupera chiodi a sgancio rapido - Con recuperador de vástagos
- Vacuum stem collection - Aspiration des tiges - Absaugen des Restdornes genutzt - Aspirazione sottovuoto chiodi - Con aspiración de vástagos

RIVQUICK® P1000

	Ø							
	2,4	3,0	3,2	4,0	4,8	5,0	6,0	6,4
Alu - Alu - Alu - Allu - Alu	☐	☐	☐	☐	☐			
Zinc plated - Acier zingué - Stahl verzinkt Acciaio zincato - Acero cincado	☐	☐	☐	☐	☐			
Stainless steel - Inox - Edelstahl - Inox - Inox	☐	☐	☐	☐	☐			

 **226 030** 01000







RIVQUICK® P2000

	Ø							
	2,4	3,0	3,2	4,0	4,8	5,0	6,0	6,4
Alu - Alu - Alu - Allu - Alu				☐	☐	☐	☐	☐
Zinc plated - Acier zingué - Stahl verzinkt Acciaio zincato - Acero cincado				☐	☐	☐	☐	☐
Stainless steel - Inox - Edelstahl - Inox - Inox				☐	☐	☐	☐	☐

 **226 031** 01000



-  Recommended for RIVQUICK® Varibulb and RIVQUICK® Varibolt Ø 4.8 mm.
To set RIVQUICK® Varibolt, a specific nosepiece is recommended (see tools part of the catalogue).
-  Recommandé pour les gammes RIVQUICK® Varibulb et RIVQUICK® Varibolt Ø 4,8 mm.
Pour la pose de rivets RIVQUICK® Varibolt, veuillez utiliser un nez spécifique à verrouillage (voir section pièces détachées - outillage).
-  Empfohlen für RIVQUICK® Varibulb und RIVQUICK® Varibolt Ø 4,8 mm.
Zum Einbau von RIVQUICK® Varibolt Sondermundstück verwenden (siehe Ersatzteilübersicht).
-  Consigliato per RIVQUICK® Varibulb e RIVQUICK® Varibolt Ø 4,8 mm.
Per la posa dei rivetti RIVQUICK® Varibolt, utilizzate un nasello speciale (vedere parte pezzi di ricambio/utensil).
-  Recomendada para las gamas RIVQUICK® Varibulb y RIVQUICK® Varibolt Ø 4,8 mm.
Para la colocación de los remaches RIVQUICK® Varibolt, utilizar las boquillas especiales (ver la información sobre útiles y recambios contenida en este catálogo).





RIVQUICK® Hydraulic/pneumatic blind riveting tool - Appareils de pose oléopneumatiques Pneumatisch-hydraulische Blindnietwerkzeuge - Apparecchi di posa oleopneumatica Aparatos de colocación oleoneumáticos

RIVQUICK® P3000





	Ø							
	2,4	3,0	3,2	4,0	4,8	5,0	6,0	6,4
Alu - Alu - Alu - Allu - Alu					☐	☐	☐	☐
Zinc plated - Acier zingué - Stahl verzinkt Acciaio zincato - Acero cincado					☐	☐	☐	☐
Stainless steel - Inox - Edelstahl - Inox - Inox					☐	☐	☐	☐

 **226 032 01000**



-  Recommended for RIVQUICK® Varibolt and RIVQUICK® Varilock Ø 6.4 mm.
To set RIVQUICK® Varibolt, a specific nosepiece is recommended (see tools part of the catalogue).
-  Recommandé pour les gammes RIVQUICK® Varibolt et RIVQUICK® Varilock Ø 6,4 mm.
Pour la pose de rivets RIVQUICK® Varibolt, veuillez utiliser un nez spécifique à verrouillage (voir section pièces détachées - outillage).
-  Empfohlen für RIVQUICK® Varibolt und RIVQUICK® Varilock Ø 6,4 mm.
Zum Einbau von RIVQUICK® Varibolt Sondermundstück verwenden (siehe Ersatzteilübersicht).
-  Consigliato per RIVQUICK® Varibolt e RIVQUICK® Varilock Ø 6,4 mm.
Per la posa dei rivetti RIVQUICK® Varibolt, utilizzate un nasello speciale (vedere parte pezzi di ricambio/utensil).
-  Recomendada para las gamas RIVQUICK® Varibolt y RIVQUICK® Varilock Ø 6,4 mm.
Para la colocación de los remaches RIVQUICK® Varibolt, utilizar las boquillas especiales (ver la información sobre útiles y recambios contenida en este catálogo).



RIVQUICK® P series Spare parts / Tooling - Pièces détachées / Outillage - Ersatzteile -
Piezzi di ricambio / Atrezzatura - Piezas de recambio / Útiles

				
		RIVQUICK® P1000	RIVQUICK® P2000	RIVQUICK® P3000
Nose piece Embouchure Sondermundstück Nasello Boquilla 	Ø 2,4	226 030 24001		
	Ø 3,2	226 030 32001		
	Ø 4,0	226 030 40001		
	Ø 5,0	226 030 50001		
	Ø 6,0		226 031 60001	
	Ø 6,4		226 031 64001	
	Ø 4,8 Varibolt		226 031 48001	
	Ø 6,4 Varibolt			226 032 64001
1 set of jaws 3 pieces 1 jeu de mors 3 parties Klemmbackensatz dreiteilig 1 set di 3 morsetti 1 juego de mordazas en 3 partes	Ø 2,4 → Ø 6,4	226 030 00002		

RIVQUICK® P series Accessories - Accessoires - Zubehör - Optional - Opciones

		RIVQUICK® P1000	RIVQUICK® P2000	RIVQUICK® P3000
Extended Nose piece Nez de pose rallongé Sondermundstück Nasello Boquilla 	XX mm	226 030 00110	226 031 00110	226 032 00110
	XX = 110 mm	226 030 00120	226 031 00120	226 032 00120
	XX = 160 mm	226 030 00130	226 031 00130	226 032 00130
	XX = 210 mm			

RIVQUICK® Battery operated setting tools - Outils de pose à batterie - Akku-Blindnietwerkzeuge - Apparecchi di posa a batteria - Remachadoras a batería

	RIVQUICK® B2000	RIVQUICK® B3000
 Kg	2 000 g	2 100 g
Setting force - Traction - Setzkraft Trazione - Tracción	10 000 N	18 000 N
Tool stroke - Course - Gerätehub Corsa - Recorrido	20 mm	27 mm
	Li-Ion-14,4V-1,4Ah	Li-Ion-14,4V-2,8Ah

- 1/4 turn removable stem collector - Bol récupérateur de tiges démontable 1/4 de tour - Abnehmbarer Nietdorn-Auffangbehälter - Serbatoio recupera chiodi a sgancio rapido - Con recuperador de vástagos

RIVQUICK® B2000

	Ø							
	2,4	3,0	3,2	4,0	4,8	5,0	6,0	6,4
Alu - Alu - Alu - Allu - Alu	<input type="checkbox"/>	<input type="checkbox"/>	<input type="checkbox"/>	<input type="checkbox"/>	<input type="checkbox"/>	<input type="checkbox"/>	<input type="checkbox"/>	<input type="checkbox"/>
Zinc plated - Acier zingué - Stahl verzinkt Acciaio zincato - Acero cincado	<input type="checkbox"/>	<input type="checkbox"/>	<input type="checkbox"/>	<input type="checkbox"/>	<input type="checkbox"/>	<input type="checkbox"/>	<input type="checkbox"/>	<input type="checkbox"/>
Stainless steel - Inox - Edelstahl - Inox - Inox	<input type="checkbox"/>	<input type="checkbox"/>	<input type="checkbox"/>	<input type="checkbox"/>	<input type="checkbox"/>	<input type="checkbox"/>	<input type="checkbox"/>	<input type="checkbox"/>

 226 040 01000



RIVQUICK® B3000

	Ø							
	2,4	3,0	3,2	4,0	4,8	5,0	6,0	6,4
Alu - Alu - Alu - Allu - Alu	<input type="checkbox"/>	<input type="checkbox"/>	<input type="checkbox"/>	<input type="checkbox"/>	<input type="checkbox"/>	<input type="checkbox"/>	<input type="checkbox"/>	<input type="checkbox"/>
Zinc plated - Acier zingué - Stahl verzinkt Acciaio zincato - Acero cincado	<input type="checkbox"/>	<input type="checkbox"/>	<input type="checkbox"/>	<input type="checkbox"/>	<input type="checkbox"/>	<input type="checkbox"/>	<input type="checkbox"/>	<input type="checkbox"/>
Stainless steel - Inox - Edelstahl - Inox - Inox	<input type="checkbox"/>	<input type="checkbox"/>	<input type="checkbox"/>	<input type="checkbox"/>	<input type="checkbox"/>	<input type="checkbox"/>	<input type="checkbox"/>	<input type="checkbox"/>











 226 041 01000











RIVQUICK® B series Spare parts / Tooling - Pièces détachées / Outillage - Ersatzteile -
 Piezzi di ricambio / Atrezzatura - Piezas de recambio / Útiles

			
		RIVQUICK® B2000	RIVQUICK® B3000
Nose piece Embouchure Sondermundstück Nasello Boquilla 	Ø 2,4	226 040 24001	
	Ø 3,2	226 040 32001	
	Ø 4,0	226 040 40001	
	Ø 5,0	226 040 50001	
	Ø 6,0		226 041 60001
	Ø 6,4		226 041 64001
	Ø 4,8 Varibolt		226 041 48002
	Ø 6,4 Varibolt		226 041 64003
1 set of jaws 3 pieces 1 jeu de mors 3 parties Klemmbackensatz dreiteilig 1 set di 3 morsetti 1 juego de mordazas en 3 partes	Ø 2,4 → Ø 6,0	226 040 00004	
	Ø 6,4		226 041 00004
Battery Batterie Akku Batteria Bateria 	Li-Ion-14,4V-1,4Ah	226 040 00018	
	Li-Ion-14,4V-2,8Ah	226 040 00019	
Battery charger Chargeur de batterie Ladegerät Caricabatteria Cargador de batería 	100-240V~50-60Hz-1A	226 040 00020	

RIVQUICK® Part number index - Index numérique - Numerisches Verzeichnis - Indice per codici -
 Índice por nro. de referencia

 Cod.		 Cod.		 Cod.		 Cod.		 Cod.	
220 331 32080	7	221 314 48180	11	221 321 60100	13	221 351 40120	18	221 413 48450	19
220 331 40060	7	221 314 48200	11	221 321 60120	13	221 351 40140	18	221 413 48500	19
220 331 40080	7	221 314 48240	11	221 321 60150	13	221 351 40160	18		
220 331 40100	7	221 314 48260	11	221 321 60180	13	221 351 40200	18	221 431 32080	22
220 331 40130	7	221 314 48300	11	221 321 60220	13	221 351 48060	18	221 431 32095	22
220 331 48080	7	221 314 48350	11	221 321 60260	13	221 351 48080	18	221 431 32120	22
220 331 48100	7	221 314 48400	11	221 321 60300	13	221 351 48100	18	221 431 40080	22
220 331 48200	7			221 321 64080	13	221 351 48120	18	221 431 40095	22
		221 316 32080	12	221 321 64100	13	221 351 48140	18	221 431 40120	22
220 611 30060	7	221 316 32100	12	221 321 64120	13	221 351 48160	18	221 431 40160	22
220 611 32060	7	221 316 32120	12	221 321 64150	13	221 351 48180	18	221 431 48095	22
220 611 32080	7	221 316 32140	12	221 321 64180	13	221 351 48200	18	221 431 48120	22
220 611 40060	7	221 316 32160	12	221 321 64220	13	221 351 48260	18		
220 611 40080	7	221 316 40080	12	221 321 64260	13	221 351 48300	18	221 478 40160	20
220 611 40100	7	221 316 40100	12	221 321 64300	13			221 478 40200	20
220 611 40120	7	221 316 40120	12			221 371 32060	17	221 478 40250	20
220 611 48080	7	221 316 40140	12	221 322 32080	14	221 371 32080	17	221 478 48160	20
220 611 48160	7	221 316 40160	12	221 322 32100	14	221 371 32100	17	221 478 48200	20
220 611 48200	7	221 316 40200	12	221 322 32120	14	221 371 32120	17	221 478 48250	20
220 611 60120	7	221 316 48100	12	221 322 40080	14	221 371 40060	17		
		221 316 48120	12	221 322 40100	14	221 371 40080	17	221 611 24050	8
221 211 32080	23	221 316 48140	12	221 322 40120	14	221 371 40100	17	221 611 24060	8
221 211 32095	23	221 316 48160	12	221 322 40140	14	221 371 40120	17	221 611 24070	8
221 211 32115	23	221 316 48180	12	221 322 48100	14	221 371 40140	17	221 611 24080	8
221 211 40100	23	221 316 48200	12	221 322 48120	14	221 371 40160	17	221 611 24100	8
221 211 40130	23	221 316 48240	12	221 322 48140	14	221 371 40200	17	221 611 24120	8
221 211 40170	23	221 316 48260	12	221 322 48160	14	221 371 48080	17	221 611 30050	8
221 211 48110	23	221 316 48300	12	221 322 48200	14	221 371 48100	17	221 611 30060	8
221 211 48150	23	221 316 48350	12			221 371 48120	17	221 611 30062	24
221 211 48170	23	221 316 48400	12	221 331 30060	15	221 371 48140	17	221 611 30063	24
221 211 48250	23			221 331 30080	15	221 371 48160	17	221 611 30064	24
		221 321 30060	13	221 331 30100	15	221 371 48180	17	221 611 30070	8
221 216 48100	23	221 321 30070	13	221 331 30120	15	221 371 48200	17	221 611 30072	24
221 216 48160	23	221 321 30080	13	221 331 32060	15			221 611 30073	24
221 216 48250	23	221 321 30090	13	221 331 32080	15	221 381 32060	25	221 611 30074	24
		221 321 30100	13	221 331 32100	15	221 381 32080	25	221 611 30080	8
221 312 24060	10	221 321 30120	13	221 331 32120	15	221 381 32100	25	221 611 30082	24
221 312 24080	10	221 321 32060	13	221 331 40060	15	221 381 40080	25	221 611 30083	24
221 312 24100	10	221 321 32070	13	221 331 40080	15	221 381 40100	25	221 611 30084	24
221 312 30070	10	221 321 32080	13	221 331 40100	15	221 381 40120	25	221 611 30090	8
221 312 30090	10	221 321 32090	13	221 331 40120	15	221 381 40140	25	221 611 30092	24
221 312 30110	10	221 321 32100	13	221 331 40140	15	221 381 48080	25	221 611 30093	24
221 312 30270	10	221 321 32110	13	221 331 40160	15	221 381 48100	25	221 611 30094	24
221 312 32090	10	221 321 32120	13	221 331 40200	15	221 381 48120	25	221 611 30100	8
221 312 32110	10	221 321 32160	13	221 331 48080	15	221 381 48140	25	221 611 30102	24
221 312 40070	10	221 321 40060	13	221 331 48100	15			221 611 30103	24
221 312 40090	10	221 321 40070	13	221 331 48120	15	221 411 32080	21	221 611 30104	24
221 312 40110	10	221 321 40080	13	221 331 48140	15	221 411 32095	21	221 611 30110	8
221 312 40120	10	221 321 40090	13	221 331 48160	15	221 411 32110	21	221 611 30112	24
221 312 40140	10	221 321 40100	13	221 331 48180	15	221 411 32115	21	221 611 30113	24
221 312 40160	10	221 321 40110	13	221 331 48200	15	221 411 32130	21	221 611 30114	24
221 312 40180	10	221 321 40120	13	221 331 48240	15	221 411 40080	21	221 611 30120	8
221 312 40200	10	221 321 40140	13	221 331 64120	15	221 411 40100	21	221 611 30122	24
221 312 48070	10	221 321 40160	13	221 331 64150	15	221 411 40115	21	221 611 30123	24
221 312 48090	10	221 321 40180	13	221 331 64180	15	221 411 40130	21	221 611 30124	24
221 312 48110	10	221 321 40200	13	221 331 64220	15	221 411 40145	21	221 611 30140	8
221 312 48120	10	221 321 40240	13	221 331 64260	15	221 411 48095	21	221 611 30160	8
221 312 48140	10	221 321 40300	13	221 331 64300	15	221 411 48110	21	221 611 30180	8
221 312 48160	10	221 321 48060	13			221 411 48125	21	221 611 32050	8
221 312 48180	10	221 321 48070	13	221 336 48100	16	221 411 48155	21	221 611 32060	8
221 312 48200	10	221 321 48080	13	221 336 48120	16	221 411 48180	21	221 611 32062	24
221 312 48260	10	221 321 48090	13	221 336 48140	16	221 411 48220	21	221 611 32063	24
221 312 48300	10	221 321 48100	13	221 336 48160	16			221 611 32064	24
		221 321 48110	13	221 336 48200	16	221 413 40120	19	221 611 32070	8
221 314 40080	11	221 321 48120	13			221 413 40160	19	221 611 32072	24
221 314 40100	11	221 321 48140	13	221 351 30060	18	221 413 40200	19	221 611 32073	24
221 314 40120	11	221 321 48160	13	221 351 30080	18	221 413 40240	19	221 611 32074	24
221 314 40140	11	221 321 48180	13	221 351 30100	18	221 413 48120	19	221 611 32080	8
221 314 40160	11	221 321 48200	13	221 351 32060	18	221 413 48140	19	221 611 32082	24
221 314 40200	11	221 321 48240	13	221 351 32080	18	221 413 48160	19	221 611 32083	24
221 314 48080	11	221 321 48260	13	221 351 32100	18	221 413 48200	19	221 611 32084	24
221 314 48100	11	221 321 48300	13	221 351 32120	18	221 413 48240	19	221 611 32090	8
221 314 48120	11	221 321 48350	13	221 351 40060	18	221 413 48300	19	221 611 32092	24
221 314 48140	11	221 321 48400	13	221 351 40080	18	221 413 48350	19	221 611 32093	24
221 314 48160	11	221 321 60080	13	221 351 40100	18	221 413 48400	19	221 611 32094	24

RIVQUICK® Part number index - Index numérique - Numerisches Verzeichnis - Indice per codici -
 Índice por nro. de referencia

 Cod.		 Cod.		 Cod.		 Cod.	
221 611 32100	8	221 611 48093	24	221 823 32090	29	226 032 01000	38
221 611 32102	24	221 611 48094	24	221 823 32110	29	226 032 64001	39
221 611 32103	24	221 611 48100	9	221 823 40070	29	226 032 00110	39
221 611 32104	24	221 611 48102	24	221 823 40090	29	226 032 00120	39
221 611 32110	8	221 611 48103	24	221 823 40120	29	226 032 00130	39
221 611 32112	24	221 611 48104	24	221 833 32070	29	226 040 01000	40
221 611 32113	24	221 611 48110	9	221 833 32090	29	226 040 24001	41
221 611 32114	24	221 611 48112	24	221 833 32110	29	226 040 32001	41
221 611 32120	8	221 611 48113	24	221 833 40070	29	226 040 40001	41
221 611 32122	24	221 611 48114	24	221 833 40090	29	226 040 50001	41
221 611 32123	24	221 611 48120	9	221 833 40120	29	226 040 00004	41
221 611 32124	24	221 611 48122	24	223 821 48100	31	226 040 00018	41
221 611 32140	8	221 611 48123	24	223 821 48121	29	226 040 00019	41
221 611 32160	8	221 611 48124	24	223 821 48140	31	226 040 00020	41
221 611 32180	8	221 611 48140	9	223 821 48146	29	226 041 01000	40
221 611 32200	8	221 611 48142	24	223 821 64140	31	226 041 60001	41
221 611 40050	8	221 611 48143	24	223 821 64190	31	226 041 64001	41
221 611 40060	8	221 611 48144	24	223 822 48130	31	226 041 48002	41
221 611 40070	8	221 611 48160	9	223 822 64160	31	226 041 64003	41
221 611 40072	24	221 611 48162	24	223 823 64170	29	226 041 00004	41
221 611 40073	24	221 611 48163	24	223 823 64200	29		
221 611 40074	24	221 611 48164	24	223 824 64150	34		
221 611 40080	8	221 611 48180	9	223 824 64156	34		
221 611 40082	24	221 611 48200	9	223 824 64170	34		
221 611 40083	24	221 611 48220	9	223 824 64190	34		
221 611 40084	24	221 611 48240	9	223 824 64210	34		
221 611 40090	8	221 611 48260	9	223 824 64230	34		
221 611 40092	24	221 611 48280	9	223 831 48100	32		
221 611 40093	24	221 611 48300	9	223 831 48129	29		
221 611 40094	24	221 611 48350	9	223 831 48140	32		
221 611 40100	8	221 611 48400	9	223 831 48155	29		
221 611 40102	24	221 611 48450	9	223 831 48180	29		
221 611 40103	24	221 611 48500	9	223 831 64140	32		
221 611 40104	24	221 611 50060	9	223 831 64190	32		
221 611 40110	8	221 611 50080	9	223 832 64160	32		
221 611 40112	24	221 611 50100	9	223 833 64170	29		
221 611 40113	24	221 611 50120	9	223 833 64200	29		
221 611 40114	24	221 611 50140	9	225 020 00000	36		
221 611 40120	8	221 611 50160	9	225 020 00501	36		
221 611 40122	24	221 611 50180	9	225 210 00000	36		
221 611 40123	24	221 611 50200	9	225 220 00000	36		
221 611 40124	24	221 611 50220	9	226 021 00901	38		
221 611 40140	8	221 611 50240	9	226 021 00902	38		
221 611 40142	24	221 611 50260	9	226 030 00002	38		
221 611 40143	24	221 611 50280	9	226 030 01000	37		
221 611 40144	24	221 611 50300	9	226 030 24001	39		
221 611 40160	8	221 611 60080	9	226 030 32001	39		
221 611 40162	24	221 611 60100	9	226 030 40001	39		
221 611 40163	24	221 611 60120	9	226 030 50001	39		
221 611 40164	24	221 611 60140	9	226 030 00002	39		
221 611 40180	8	221 611 60160	9	226 030 00110	39		
221 611 40182	24	221 611 60180	9	226 030 00120	39		
221 611 40183	24	221 611 60200	9	226 030 00130	39		
221 611 40184	24	221 611 60220	9	226 031 01000	37		
221 611 40200	8	221 611 60260	9	226 031 60001	39		
221 611 40202	24	221 611 60300	9	226 031 64001	39		
221 611 40203	24	221 611 60350	9	226 031 48001	39		
221 611 40204	24	221 611 60400	9	226 031 00110	39		
221 611 40220	8	221 611 64100	9	226 031 00120	39		
221 611 40240	8	221 611 64120	9	226 031 00130	39		
221 611 40260	8	221 611 64160	9				
221 611 40280	8	221 611 64180	9				
221 611 40300	8	221 611 64220	9				
221 611 40350	8	221 611 64260	9				
221 611 48060	9	221 611 64300	9				
221 611 48070	9	221 611 64350	9				
221 611 48072	24	221 611 64400	9				
221 611 48073	24	221 611 78150	9				
221 611 48074	24	221 611 78180	9				
221 611 48080	9	221 611 78220	9				
221 611 48082	24	221 611 78260	9				
221 611 48083	24	221 611 78300	9				
221 611 48084	24	221 611 78350	9				
221 611 48090	9	221 823 32070	29				
221 611 48092	24						

Böllhoff International with companies in:

Argentina
Austria
Brazil
Canada
China
Czech Republic
France
Germany
Hungary
India
Italy
Japan
Korea
Mexico
Poland
Romania
Russia
Slovakia
Spain
Switzerland
Turkey
United Kingdom
USA

Apart from these 23 countries, Böllhoff supports its international customers in other important industrial markets in close partnership with agents and dealers.

Subject to technical change.
Reprinting, even in extract form, only permitted with express consent.
Observe protective note according to ISO 16016.

Böllhoff Group
Please find your local contact on www.boellhoff.com
or contact us under fasteningtechnology@boellhoff.com

