



HELICOIL® Plus

Thread technology for
high-strength fastenings

– imperial threads

UNC, UNF, BSW, BSF, BSP/G, BA

BÖLLHOFF

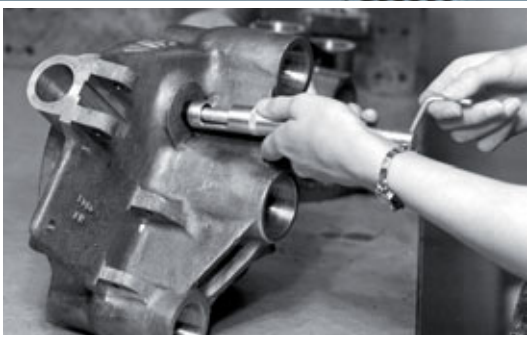

System modules – the fastener

	Page
Technology	05
Designs	06
A close look at the advantages	08
Modular system	10
Materials	12
Design guidelines	13
Fields of application	14
Installation	16
Technical data and item numbers	18

System modules – the tool

All taps at a glance	34
Thread tolerances for imperial threads	36
Manual taps	38
Machine taps	40
Internal thread gauges	42

Installation

Installation mandrels	46
Installation tools	
Battery installation tools	48
Electrical installation tools	49
Pneumatic installation tools	50
Mechanical installation tools	52
Accessories	56
Automatic installation	57
Manual installation tools	58
Tang break-off and extraction tools	60



Large picture (left): Application example

HELICOIL® thread inserts



Can you imagine a world without screws? Even today, the screw is the most widely used fastening element for detachable joints. Optimised tightening methods and high-strength screws allow constant improvement. Considerably higher forces can be transmitted so that the dimension or total number of required screws can be reduced. However, only highly sustainable nut threads permit high-strength screw joints. This is where our HELICOIL® thread technology is used.

Your advantages – an overview:

- High thread loading
- Increased quality and value
- Wear-resistant, low and constant thread friction
- Strong
- Corrosion and temperature resistant
- Cost-effective
- Tight fit
- Screw locking

Structural component – thread reinforcement and repair

HELICOIL® is thread reinforcement and repair.

Threads are reinforced whenever low-strength materials (e.g. aluminium, aluminium-magnesium alloys and fibre-reinforced plastics) are used. The nut thread is wear-resistant even in cases of frequent use. HELICOIL® allows miniaturisation and lightweight construction for the development of production parts. The HELICOIL® thread insert has been tried and tested for more than 60 years and has become a widely used structural component.

Worldwide, HELICOIL® thread inserts are approved for economical and lasting repair of damaged or worn out threads.

Apart from repair of valuable individual components, parts used in large-scale production which have been rejected due to faults during thread production can be reintegrated into the production process.

Technology

Thanks to continuous optimisation, the HELICOIL® Plus is now much easier to install. “Plus” refers to the special start of the thread, compared to the HELICOIL® Classic. The thread insert is a wire with rhombic profile formed into an elastic spiral. It is positioned and screwed in like a screw. To screw in the thread insert, all you need is an installation mandrel with thread dimensions similar to a tap of the same nominal diameter. However, existing tools of the commonly used design can still be used for installation. Thanks to the considerably wider range of tools to be used for installation, installation times are up to 20 % shorter than for previous methods.

If through-hole threads are required, after installation, the tang can be broken off at the notch (predetermined breaking point).

HELICOIL® Plus produces high-strength threads transferring forces from flank to flank into the holding thread. It is a highly reliable system for which German and international industrial property rights have been filed. HELICOIL® Plus are thread inserts produced according to consistent material and quality specifications and meet the requirements of national standardisation as well as aeronautical and military standards. Apart from that, leading large-scale users base their manufacturing standards on this system.



Defective thread



Repaired thread



R_m = min. tensile strength 1400 N/mm² (1 N/mm² equals 1 MPa)
 HV = Vickers hardness 425 HV 0.2 min.
 R_z = roughness depth approx. 2.5 µm
 μ_G = reduced thread friction, results in increased preload-force FV at constant tightening torque
 τ_t = reduced torsion stress in the screw shank

HELICOIL® Plus Free Running*



Every thread of the thread insert with precision-formed, rhombic profile is free running. The result is an internal thread true to gauge that can be used from both ends. The dimensional stability of the thread formed by HELICOIL® Plus meets the demands on international standard specifications. The advantages of the HELICOIL® Plus system are particularly apparent with respect to processing and tools and result in shorter cycle times.

HELICOIL® Plus Screwlock*



This thread insert has an additional screw-locking area. One or several polygonal-shaped threads clamp the flanks of the installed screw. The elastically resilient frictional locking results in prevailing torques. These screw locking torques meet the demands of technical delivery terms regarding international standard specifications. However, the prevailing torques can also be adjusted as required for the corresponding application, e.g. for securing of setting screws. HELICOIL® Plus Screwlock can only be used with screws of higher property classes ($R_m > 800 \text{ N/mm}^2$). Common lubricants according to the manufacturers' recommendations should be used for highly alloyed screws.

The advantages of the HELICOIL® Plus system are particularly apparent with respect to processing and tools and result in shorter cycle times.

HELICOIL® Classic Free Running*



Every thread of the thread insert with precision-formed, rhombic profile is free running. The result is an internal thread true to gauge that can be used from both ends. The dimensional stability of the thread formed by HELICOIL® Plus meets the demands on international standard specifications.

HELICOIL® Classic Screwlock*



This thread insert has an additional screw-locking area. One or several polygonal-shaped threads clamp the flanks of the installed screw. The elastically resilient frictional locking results in prevailing torques. These screw locking torques meet the demands of technical delivery terms regarding international standard specifications. However, the prevailing torques can also be adjusted as required for the corresponding application, e.g. for securing of setting screws. HELICOIL® Classic Screwlock can only be used with screws of higher property classes ($R_m > 800 \text{ N/mm}^2$). Common lubricants according to the manufacturers' recommendations should be used for highly alloyed screws.

*For standard specifications, see page 17a.

HELICOIL® Tangfree Free Running*



You do not need a tang to install these thread inserts. Therefore, tang break and removal are not required. Combined with the matching installation tools, the current innovation status in the HELICOIL® technology is a perfect addition to the HELICOIL® product family.

Simply order the separate catalogue No 0150.

HELICOIL® Tangfree Screwlock*



HELICOIL® Tangfree Screwlock has the same advantages as HELICOIL® Tangfree. In addition, there is a screw-locking area. The screw is locked by one or several polygonal-shaped threads clamping the flanks of the screwed in screw. The elastically resilient frictional locking results in prevailing torques. These screw locking torques meet the demands of technical delivery terms regarding international standard specifications. HELICOIL® Tangfree Screwlock can only be used with screws of higher property classes ($R_m > 800 \text{ N/mm}^2$). Common lubricants according to the manufacturers' recommendations shall be used for highly alloyed screws. This thread insert is widely used in the aviation industry.

Simply order the separate catalogue No 0150.

HELICOIL® Locknuts



HELICOIL® locknuts consist of a nut body and an integrated HELICOIL® Plus Screwlock thread insert. One or several polygonal-shaped threads clamp the flanks of the screwed in screw resulting in elastically resilient frictional locking. These screw locking torques meet the demands of technical delivery terms regarding international standard specifications. Moreover, they can also be adjusted as required for the corresponding application. HELICOIL® nuts are available in different materials. Simply order the separate catalogue No 0560.

RIVKLE® Aero



RIVKLE® Aero combines a high-strength stainless steel blind rivet nut and a HELICOIL® Screwlock. These two perfectly matching fasteners provide considerable benefits for screwed connections on thin-walled components with high mechanical requirements. Due to the polygonal-shaped thread of the HELICOIL® Screwlock thread insert, there is a locking effect on the flanks of the screw or bolt to be screwed in.

As a result, there is a highly elastically resilient frictional locking so that the screw is locked to prevent self-unscrewing.

Simply order the separate catalogue No 2307.

*For standard specifications, see page 17a.

HELICOIL® thread inserts – a close look at the advantages

Wear resistance

HELICOIL® Plus thread inserts are made of austenitic chrome-nickel steel (minimum tensile strength 1,400 N/mm²). The high surface quality of the rolled thread ensures a high-strength, wear-resistant thread with an extremely small and constant thread friction torque. Therefore, a higher, constant preload-force is achieved for repeated cycles at the same tightening torque. The utilisation of the yield point of high-strength screws is improved. Torsion stress is considerably reduced. Compared to tapped threads, the surface roughness of the HELICOIL® Plus is reduced by 90 %.

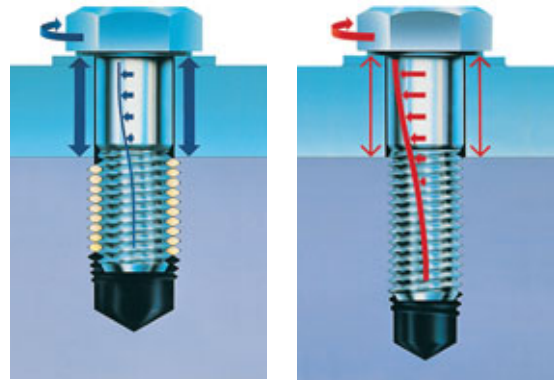

Strength

The elastic properties of the HELICOIL® Plus thread insert allow a uniform load and stress distribution. An optimum flank contact is achieved. Variable pitches and angles are compensated for over the entire length of the thread insert. Force transmission from bolt to nut thread is optimised. The quality of the screw joint is considerably increased – for static as well as dynamic operating loads.

Due to the improved distribution of the preload-force, the fatigue strength of dynamically loaded screws is increased. This is why the HELICOIL® is also suitable for use in threads in high-strength materials, e.g. steel or cast iron alloys.

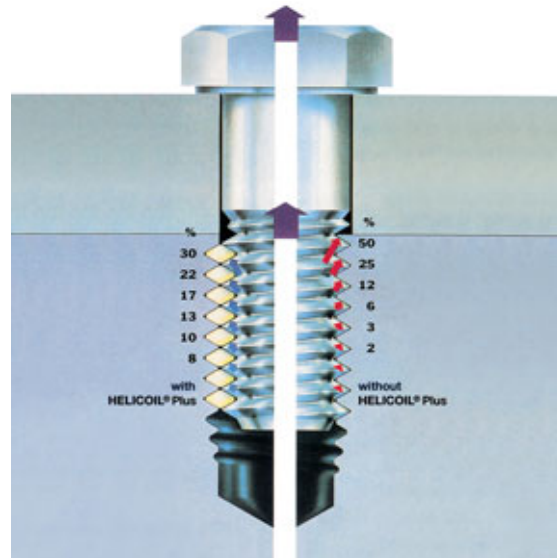

Corrosion and temperature resistance

The standard material of the HELICOIL® Plus prevents seizing of screws under environmental influences. HELICOIL® Plus thread inserts of nickel-based materials are available for thermally highly stressed screw joints. Elasticity and spring force remain constant. For materials particularly susceptible to corrosion, such as magnesium, the HELICOIL® Plus made of hard-coated high-strength aluminium is used. This prevents contact corrosion caused by galvanic action.



Tight fit

When not installed, the outside diameter of the HELICOIL® Plus exceeds the receiving thread by a defined amount. In combination with the high spring force of the material, this difference in dimension results in radial expansion and therefore in the tight and clearance-free fit in the nut thread. Additional locking elements or adhesive – as are common for fixed bushes – are therefore obsolete.

If you use impact wrenches, please contact us. We will be happy to help you.

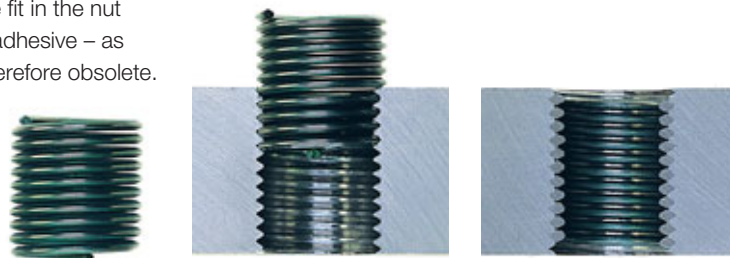

Screw locking

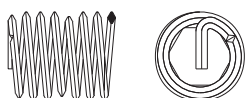

Thread technology and the polygonal-shaped thread of the HELICOIL® Plus Screwlock lead to a high degree of frictional locking and thus prevents the screw unscrewing and its losing. Additional locking of the joint with split pins, wires or washers is not required. Costs are reduced and installation is easier.

Maximum locking torque for HELICOIL® Plus and HELICOIL® Plus Screwlock as per NASM 8846 for insertion or removal and minimum release torque for screw fasteners Values in Nm														
UNC = American National Coarse thread														
Thread	1-64	2-56	3-48	4-40	5-40	6-32	8-32	10-24	12-24	1/4"-20	5/16"-18	3/8"-16	7/16"-14	1/2"-13
Max. lock torque Insertion or removal	0.11	0.14	0.23	0.34	0.53	0.68	1.02	1.47	2.71	3.39	6.78	9.04	11.30	16.95
Min. release torque 1.-15 screws, min.	0.01	0.02	0.05	0.07	0.09	0.11	0.17	0.23	0.34	0.51	0.85	1.36	1.86	2.71
UNF = American National Fine thread														
Thread	3-56	4-48	6-40	8-36	10-32	12-28	1/4"-28	5/16"-24	3/8"-24	7/16"-20	1/2"-20	-	-	-
Max. lock torque Insertion or removal	0.23	0.34	0.68	1.02	1.47	2.71	3.39	6.78	9.04	11.30	16.95	-	-	-
Min. release torque 1.-15 screws, min.	0.05	0.07	0.11	0.17	0.23	0.34	0.40	0.73	1.07	1.58	2.03	-	-	-

Locking torques of other inch sizes on request.

Friction

Thread friction and its scatter range can be reduced if a HELICOIL® is used. The dispersion range can be restricted. (For example: If the thread friction value μG of a property class 10.9 carbon steel screw, screwed into a tapped nut thread ranges between 0.12 and 0.18, the μG values range between 0.11 and 0.13 if a coil thread insert is used.) For a torque-controlled screw tightening application, the screw preload-force can be adjusted more precisely and the yield point of the screw utilised more efficiently. Simultaneously, the preload force is increased during screw breakage due to reduced torsional stress.

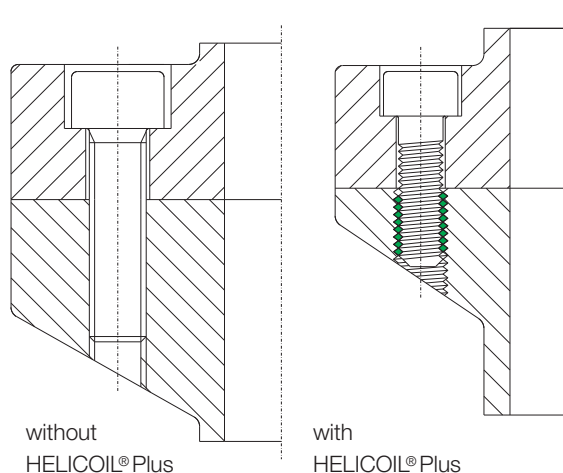

Downsizing

Engineers can choose almost any material. The HELICOIL® Plus corresponds to today's trend toward lightweight construction (e.g. aluminium and magnesium) because this method of thread reinforcement combines minimum space requirements and high strength. High-strength screws are therefore also perfectly suitable for low-shear materials. A reduced number of joints and smaller screw sizes save material, installation space and weight – at high fatigue strength. These are definite advantages of the HELICOIL® system.



HELICOIL® modular system

The HELICOIL® has been tried and tested for more than 60 years and has become a renowned structural component. There is a solution to almost every task related to this thread technology.

Thread types	Metric coarse thread DIN ISO 13 1	Metric fine thread DIN ISO 13 (T02-T11)	Pipe thread DIN EN ISO 228/1 G	UNC thread NASM 21209
Designs	 HELICOIL® Plus Free Running	 HELICOIL® Plus Screwlock	 HELICOIL® Tangfree	
Materials	Stainless steel A2 material No 1.4301	Stainless steel A4 material No 1.4571	Bronze material No 2.1020.34	Inconel X 750 material No 2.4669
Surfaces	Bright		Tin-plated G100 / G300	Dry film lubricated

HELICOIL® further catalogues



HELICOIL® Plus
HELICOIL® Plus thread technology for high-strength fastenings
Catalogue No 0100

<http://www.boellhoff.de/en/helicoil-plus>

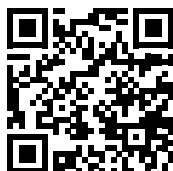

HELICOIL® Tangfree
The tangfree coil thread insert for a high-strength thread
Catalogue No 0150

<http://www.boellhoff.de/en/helicoil-tangfree>



<p>UNF thread NASM 21209</p>				<p>BSW BS 84</p>				<p>BSF BS 84</p>				<p>BA BS 93</p>			
<p>HELICOIL® Tangfree Screwlock</p>				<p>HELICOIL® Classic Free Running</p>				<p>HELICOIL® Classic Screwlock</p>				<p>Thread types</p>			
<p>Nimonic 90 material No 2.4632</p>				<p>Aluminium material No 3.4365</p>				<p>Designs</p>				<p>Materials</p>			
<p>Cadmium plated</p>				<p>Silver plated</p>				<p>Hard coated</p>				<p>Coloured: red, green, blue, yellow</p>			
<p>Surfaces</p>															

Not all combinations are viable.

HELICOIL® Plus
Repairing of damaged threads
Catalogue No 0180
<http://www.boellhoff.de/en/thread-repair>



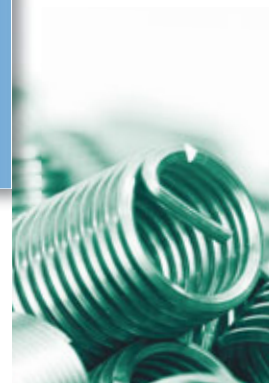
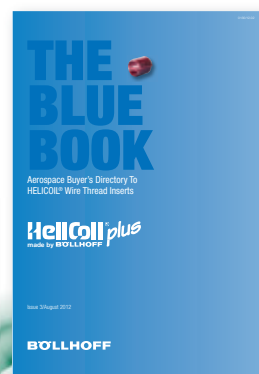

THE BLUE BOOK
Aerospace Buyer's Directory to HELICOIL® Wire Thread Inserts
Catalogue No 0130
<http://www.boellhoff.de/the-blue-book>



Materials

The overview table shows the most common materials with specifications.

 Materials ①	 Temperature resistance	 Minimum tensile strength at room temperature	Examples of use
Stainless steel A 2 X5 CrNi 18 10 material No 1.4301	low temperature –196°C short-term 425°C long-term 315°C	1400 N/mm ² *	<ul style="list-style-type: none"> ■ Standard applications for all property classes and materials ③ ■ General lightweight construction e.g. of aluminium, magnesium or aluminium alloys ②
Stainless steel A 4 X6 CrNiMoTi 17 12 2 ④ material No 1.4571	low temperature –196°C short-term 425°C long-term 315°C	1400 N/mm ² *	<ul style="list-style-type: none"> ■ Increased corrosion protection ■ Highly alloyed CrNi steel screws ③ ■ Low thread friction ■ General lightweight construction ■ Sea water/chlorine-containing water
Bronze CuSN 6 material No 2.1020.34	short-term 300°C long-term 250°C	900 N/mm ² *	<ul style="list-style-type: none"> ■ Copper workpieces ■ Moving threads ■ CrNi steel screws
Inconel X 750 NiCr 15 Fe 7 TiAl ④ material No 2.4669 Nimonic 90 NiCr 20 Co 18 Ti material No 2.4632	short-term 750°C long-term 550°C short-term 900°C long-term 600°C	1150 N/mm ² *	<ul style="list-style-type: none"> ■ Thermal load in combination with corrosion protection ■ Aerospace technology ■ Aeroplane engines ■ Turbochargers
Aluminium AlZnMgCu 1.5 ④ material No 3.4365	short-term 170°C long-term 150°C	500 N/mm ² *	<ul style="list-style-type: none"> ■ Magnesium workpieces ■ Vehicle technology ■ Lightweight construction

① Further materials and surfaces on request.
 ② If magnesium alloys are used outdoors, we recommend special measures for corrosion protection.
 ③ If CrNi screws are used, you should use a suitable coating or standard lubricant.
 ④ Delivery on request.

Note: Data only apply to uncoloured HELICOIL® Plus.

Up to M 5, the applied colour is temperature-resistant from –18°C to +200°C.

From M 6, the applied colour is temperature-resistant from –5°C to +120°C (+150°C short-term).

*1 N/mm² equals 1 MPa

Thread types and standard specifications

Thread	HELICOIL® Plus Free Running		HELICOIL® Plus Screwlock		Page
	Nominal diameter	Nominal length	Nominal diameter	Nominal length	
UNIFIED or American National Coarse threads = UNC/NC NASM 21209	2-56 to 1 1/2"-6	1 d to 2.5 d	2-56 to 3/4"-16	1 d to 2.5 d	18–27
UNIFIED or American National Fine threads = UNF/NF NASM 21209	3-56 to 1 1/2"-12	1 d to 2.5 d	3-56 to 3/4"-16	1 d to 2.5 d	
British Standard Whitworth threads = BSW	1/8" to 1 1/2"	1 d to 2.5 d	5/16" to 3/4"	1 d to 3 d	
British Standard Fine threads = BSF	3/16" to 1 1/2"	1 d to 2.5 d	3/16" to 3/4"	1 d to 2.5 d	
Pipe Thread G ISO 228/1, G British Standard Pipe threads = BSP	G 1/8" to G 1 1/2" 1/8" to 1 1/2"	1 d to 2.5 d	–	–	
British Association Standard threads = BA	0BA to 6BA	1 d to 2.5 d	0BA 2BA 4BA 6BA	1 d to 2.5 d	

HELICOIL® Plus thread inserts comply with diverse requirements and standards from general and aerospace industries.

For UNC and UNF sizes, see page 17a.

Further standards on request.

Determination of nominal length

Guide values to determine the minimum length of the HELICOIL® Plus thread insert depending on parent material and screw property class, valid for 20°C.

Strength of parent material	Screw property class									
	3.6 4.6	4.8 5.6	5.8 6.6	6.8 6.9	8.8	9.8	10.9	12.9	14.9	
Tensile strength R_m (N/mm ²)*										
to 100	1.5 d	1.5 d	2 d	2.5 d	3 d	3 d	–	–	–	
> 100 – 150	1.5 d	1.5 d	2 d	2 d	2.5 d	2.5 d	2.5 d	2.5 d	3 d	
> 150 – 200	1 d	1.5 d	1.5 d	1.5 d	2 d	2 d	2 d	2.5 d	2.5 d	
> 200 – 250	1 d	1 d	1.5 d	1.5 d	1.5 d	1.5 d	2 d	2.5 d	2.5 d	
> 250 – 300	1 d	1 d	1 d	1 d	1.5 d	1.5 d	1.5 d	2 d	2 d	
> 300 – 350	1 d	1 d	1 d	1 d	1 d	1.5 d	1.5 d	1.5 d	2 d	
> 350 – 400	1 d	1 d	1 d	1 d	1 d	1 d	1.5 d	1.5 d	1.5 d	
> 400	1 d	1 d	1 d	1 d	1 d	1 d	1.5 d	1.5 d	1.5 d	

The table of values to determine the nominal length applies to aluminium as well as to materials with a ratio from $\frac{\text{shear stress}}{\text{tensile stress}} = 0.6$ to 0.7 . Some iron cast alloys have a ratio ranging from $\frac{\text{shear stress}}{\text{tensile stress}} = 0.8$ to 1.4 . (source: VDI 2230)

For these guide values, the screw is the weaker joint member.

Lengths can be shorter than the recommended nominal lengths if tests confirm this.

Intermediate lengths are also available.

Temperature limits for validity: aluminium alloys $T_{max} = 300^\circ\text{C}$, magnesium alloys $T_{max} = 100^\circ\text{C}$.

For the design of screw joints under thermal stress, the changes of temperature-dependent material parameters must be taken into account.

* 1 N/mm² equals 1 MPa

Minimum wall thickness (related to outside diameter of the HELICOIL® receiving thread)

The minimum wall thickness mainly depends on individual operating data. These define material strength and length of thread engagement. The indicated guide value formulas apply to aluminium, cast and wrought alloys and a length of thread engagement of the HELICOIL® Plus of 1.5 d.

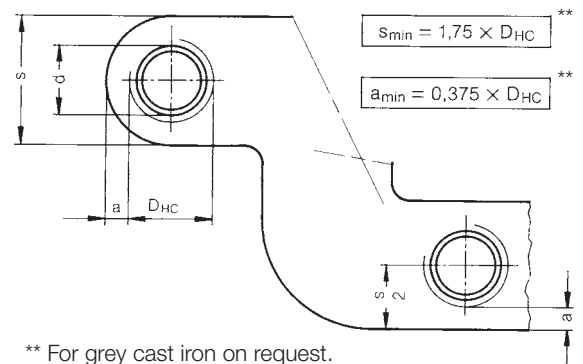

- d = nominal Ø
- D_{HC} = outside Ø of the receiving thread
- a = residual wall thickness

Diagrammatic representation with the example of UNF 1/4"-28 x 1,5 d:

HELICOIL® Plus thread insert installed

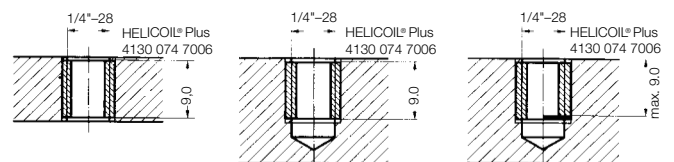

HELICOIL® Plus thread insert installed, with screw

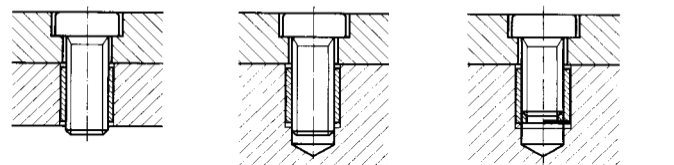

Free CAD download

We offer a free CAD download service. Download 3-D models of Böllhoff products and directly integrate them into your designs.

www.boellhoff.de/en/cad

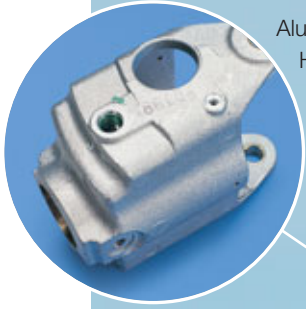

Aluminium steering gear casing
HELICOIL® Plus
Free Running
M 14 x 1.5 x 14

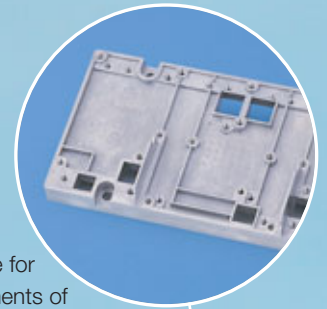

Mounting plate for
electronic components of
die-cast aluminium



High-temperature application
with Inconel HELICOIL® insert,
silver plated



Cast aluminium fitting for
car roof rails with HELICOIL® Plus
Screwlock M 6 x 6



Cast aluminium cage
protection of flush-mounted
lamp
HELICOIL® Plus
Free Running M 8 x 12



Automotive



Aerospace industry



Rail carriages



White goods



Plastics



Metal construction

Fields of application for HELICOIL® Plus thread inserts

- Gear box housing of magnesium alloys
- Thread reinforcement for oil drain plugs
- Exhaust systems
- Satellite technology
- Aeroplane engines
- Repeated installations
- Maintenance and repair
- Lamps
- Electrical appliances
- Hammer drills
- Printing presses



Magnesium bracket (G-AlSi9 Mg)
HELICOIL® Plus
Free Running M 8 x 12



Oil drain hole of an aluminium car oil sump
Thread reinforcement with HELICOIL® Plus
Free Running M 14 x 1.5 x 14

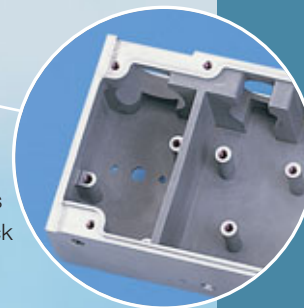

Housing for aluminium electronic components
HELICOIL® Plus Screwlock

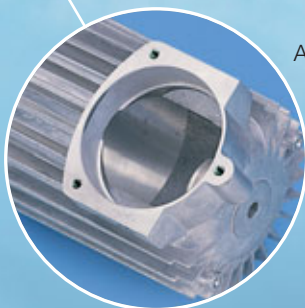

Aluminium cast alloy housing
Flange with HELICOIL® Plus
Screwlock M 5 x 10



Agricultural machinery



Construction machinery

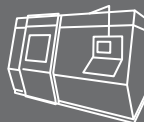

Mechanical engineering



Wind power



Electronic devices

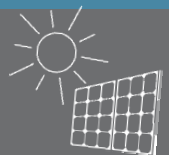

Solar

HELICOIL® Plus installation

HELICOIL® Plus thread inserts can be easily and economically installed because there are only a few basic rules to observe. There is a broad range of installation tools for efficient installation – for individual applications as well as for large-scale production. Installation phases are as follows:

Drilling

Common twist drills are used.

Notes on diameter and tapped hole depth are given on pages 18 to 27.

Prior to tapping, counter-bore 90° and deburr. Outside diameter of **countersink** = $D_{HC} + 0.1 \text{ mm}$.



Tapping

To tap the HELICOIL® Plus holding thread, system-dependent original HELICOIL® taps must be used.

Recommendations for suitable manual and machine taps are given on pages 38 to 41. The trueness to gauge of the holding thread must be checked with HELICOIL® thread plug limit gauges (see page 42).

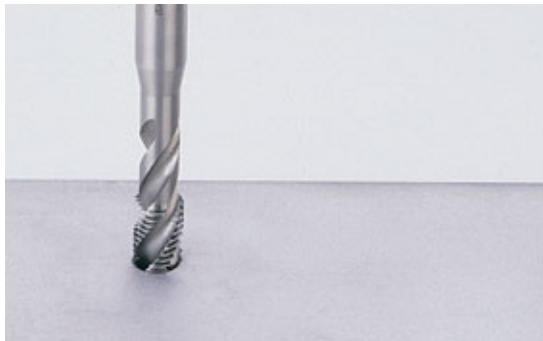

HELICOIL® Plus thread inserts
Technical data

Insertion of thread insert

The thread insert can be installed using an installation mandrel, a manual insertion tool or automatic tools. Screw the HELICOIL® Plus thread insert onto the installation mandrel with its tang facing downwards (a). HELICOIL® thread UNC > 1/2", UNF > 1/2", G > 1/2", BSW, BSF and BA specifications should be installed using a pre-stressing mandrel (b). Threads to UNC and BSW $\geq 5/8$ "-11 specifications should be installed using the fly-over tool (c).

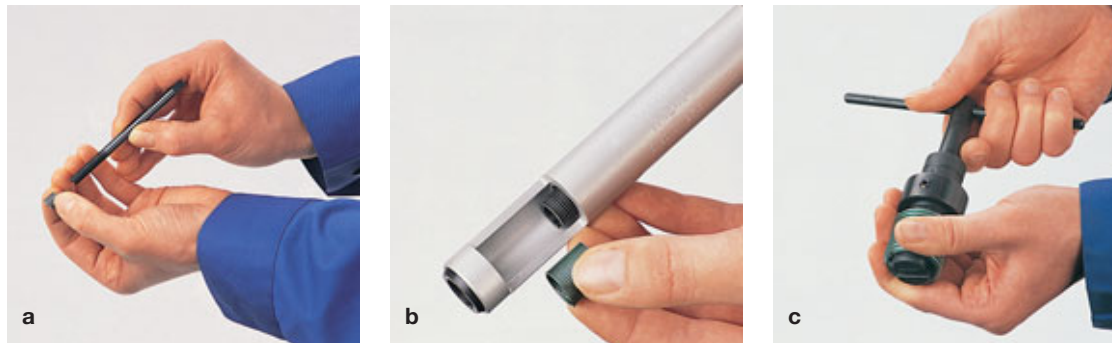

Installation

By turning the threaded mandrel (d), the mandrel (e) or the fly-over tool (f), respectively, manually or triggering the drive, the thread insert is screwed in. It must be installed at least 0.25 P below the surface (see page 17 b).

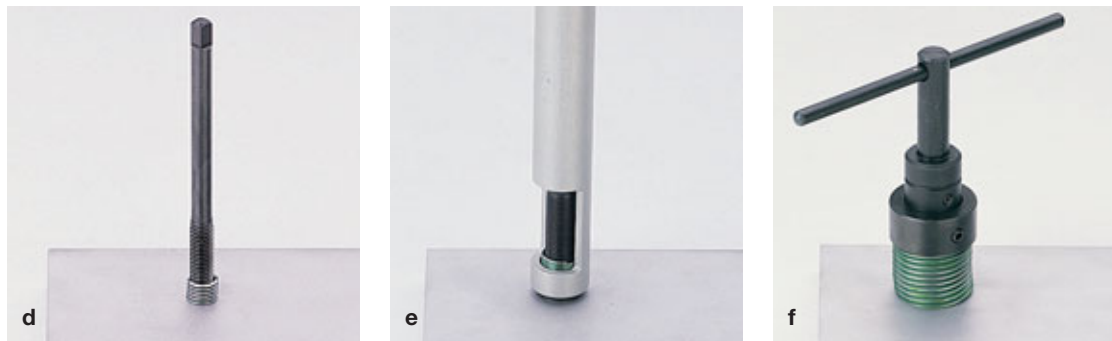

Breaking off the tang

To produce a through-hole thread, the tang is broken off at the notch. For that, a tang break-off tool is used (g and h). For 3/4" fine or standard pitch threads the tang can be removed with long nose pliers (i). For blind-hole threads, the tang does not have to be removed if the maximum screw-in depth t_3 of the screw is observed.

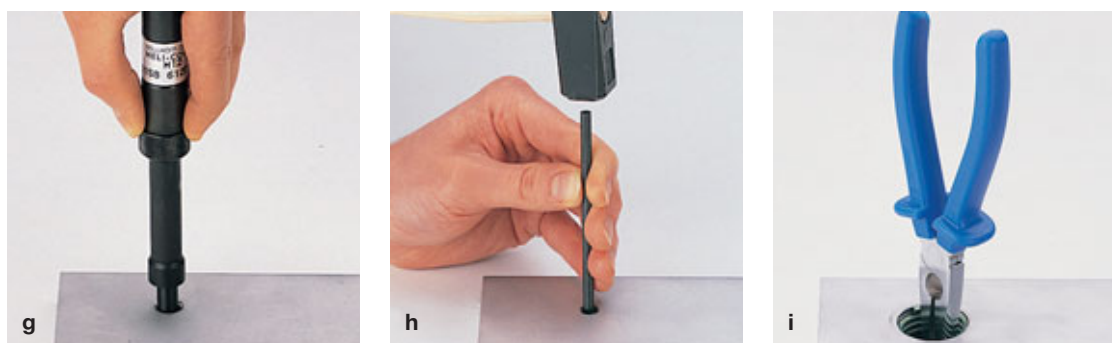

HELICOIL® Plus thread inserts in compliance with aerospace and military standards:

■ **Quality Management System:**

The Böllhoff Quality Management System (QMS) was awarded EN 9100 quality assurance certification on 5th January 2004 and is therefore an approved supplier to the European aerospace industry.

■ **HELICOIL® Plus Free Running, UNC and UNF imperial sizes**

HELICOIL® Plus Free Running inserts in imperial sizes smaller than or the same as UNC 8-32 meet the geometric definitions of the following standards:

- UNC threads: NASM 122076 – NASM 122275
- UNF threads: NASM 124651 – NASM 124850

HELICOIL® Plus Free Running inserts in imperial sizes larger than UNC 8-32 and all UNF sizes do not meet the geometric definitions of these MS standards in their non-assembled state (shape of the first thread turn of HELICOIL® Plus).

In their assembled state, all HELICOIL® Plus inserts in imperial sizes meet the specifications of these standards.

Coloring: HELICOIL® Plus Free Running inserts in imperial sizes are colored green.

■ **HELICOIL® Plus Screwlock UNC and UNF imperial sizes**

HELICOIL® Plus Screwlock inserts in imperial sizes smaller and equal UNC 8-32 meet the geometric definitions of the NASM 21209.

HELICOIL® Plus Screwlock inserts in imperial sizes larger than UNC 8-32 and all UNF sizes do not meet the geometric definitions of the NASM 21209 in their non-assembled state (shape of the first thread turn of HELICOIL® Plus).

In their assembled state, all HELICOIL® Plus Screwlock inserts in imperial sizes meet the specifications of the NASM 21209 standard.

Coloring: HELICOIL® Plus Screwlock inserts in imperial sizes are colored red as specified in the NASM 21209 standard.

■ Other standards are available on request.

■ For more information relating to compliance of our inserts with standards, please contact Böllhoff directly.

Please fold this page outward for reading

HELICOIL® Plus thread inserts

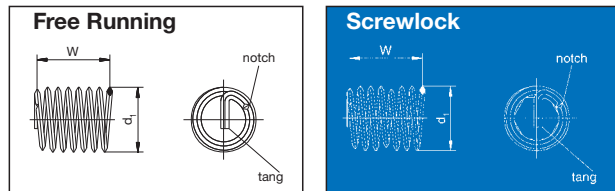

The Free Running and Screwlock thread insert control values are W and d_1 , when not inserted.
Its length can only be measured when the insert is in position.

Holding thread

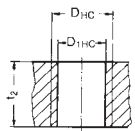

Composition

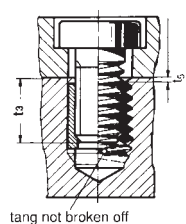
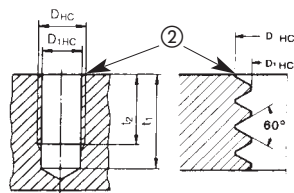
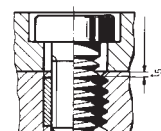

tang not broken off

- d = thread diameter
- P = pitch
- d_1 = outer diameter of thread insert prior to installation
- W = number of coils prior to installation
- D_{HC} = outer thread of tapped hole
- D_{1HC} = thread core diameter
- B = recommended twist drill diameter
- t_1 = minimum depth of core hole according to DIN 76 Part 1
- t_2 = nominal length of thread insert and minimum length of holding thread
- t_3 = maximum screw-in depth if tang has not been broken off
- t_5 = distance of thread insert from separating surface = $0.25 P$, if t_2 complies with the above mentioned minimum value

② 90° countersinking or deburring before tapping:
Countersinking diameter = $D_{HC} + 0,1 \text{ mm}$.

■ Angle of pressure 60° with UNC/UNF.
Deviating is valid for G-pipe threads of the angles of pressure 55° and for BA thread 48°.

■ By utilisation of HELICOIL® Plus thread inserts in series production it is recommended that the values t_1 and t_2 at a minimum however the size of $1 \times P$ is always added.

① Materials or surfaces are always to be recorded with the 5th digit of the ordering ref. no.:

Example :

- 0 = Stainless steel A 2, X 5 CrNi 18 10 4130 002 0005
 - 1 = Bronze, CuSn 6
 - 2 = Nimonic 90, NiCr 20 Co 18 Ti, silver plated*
 - 3 = Stainless steel A 4, X 6 CrNiMoTi 17 12 2
 - 4 = Inconel X 750, NiCr 15 Fe 7 TiAl, silver plated*
 - 5 = Inconel X 750, NiCr 15 Fe 7 TiAl, polished
 - 6 = Stainless steel A 2, X 5 CrNi 18 10, cadmium plated
 - 7 = Stainless steel A 2, X 5 CrNi 18 10, magazine loaded**
 - 8 = Bronze, CuSn 6, magazine loaded**
- Other materials upon request

Valid for UNC/NC and UNF/NF

* utilise special tools
** see pages 28 and 31

All dimensions in mm. Subject to technical modifications.

Thread inserts HELICOIL® Plus – UNC/NC = American National Coarse threads

d	P	$t_2 \text{ min.}^*$		W	d_1 min. max.	D_{1HC} min. max.	B	$t_3 \text{ max.}$	D_{HC} min.	Free Running Item No ①	Screwlock Item No ①
		x d	mm								
2-56	0.435	1 d	2.2	3.0	2.7 2.9	2.28 2.44	2.4	1.8 2.9 3.9 5.0	2.84	4130 063 6004	4132 063 6004
		1.5 d	3.3	5.25						4130 063 6006	4132 063 6006
		2 d	4.4	7.4						4130 063 6008	4132 063 6008
		2.5 d	5.5	9.6						4130 063 6010	4132 063 6010
4-40	0.635	1 d	2.9	2.8	3.6 4.0	3.00 3.15	3.1	2.5 3.9 5.4 6.8	3.67	4130 065 6004	4132 065 6004
		1.5 d	4.3	4.8						4130 065 6006	4132 065 6006
		2 d	5.8	6.8						4130 065 6008	4132 065 6008
		2.5 d	7.2	8.8						4130 065 6010	4132 065 6010
5-40	0.635	1 d	3.2	3.3	4.0 4.4	3.33 3.48	3.4	2.8 4.3 6.0 7.5	4.00	4130 066 6004	4132 066 6004
		1.5 d	4.8	5.5						4130 066 6006	4132 066 6006
		2 d	6.4	7.8						4130 066 6008	4132 066 6008
		2.5 d	7.9	10.0						4130 066 6010	4132 066 6010
6-32	0.794	1 d	3.5	2.8	4.5 4.9	3.68 3.89	3.8	3.1 4.9 6.6 8.4	4.54	4130 067 6004	4132 067 6004
		1.5 d	5.3	4.8						4130 067 6006	4132 067 6006
		2 d	7.0	6.7						4130 067 6008	4132 067 6008
		2.5 d	8.8	8.7						4130 067 6010	4132 067 6010
8-32	0.794	1 d	4.2	3.5	5.2 5.6	4.34 4.52	4.4	3.8 5.9 8.0 10.1	5.20	4130 068 6004	4132 068 6004
		1.5 d	6.3	5.9						4130 068 6006	4132 068 6006
		2 d	8.3	8.3						4130 068 6008	4132 068 6008
		2.5 d	10.5	10.7						4130 068 6010	4132 068 6010
10-24	1.058	1 d	4.8	2.9	6.2 6.6	5.06 5.28	5.2	4.3 6.7 9.1 11.6	6.20	4130 069 6004	4132 069 6004
		1.5 d	7.2	5.0						4130 069 6006	4132 069 6006
		2 d	9.6	7.1						4130 069 6008	4132 069 6008
		2.5 d	12.1	9.2						4130 069 6010	4132 069 6010
12-24	1.058	1 d	5.5	3.5	6.8 7.2	5.72 5.92	5.8	5.0 7.7 10.5 13.2	6.86	4130 070 6004	4132 070 6004
		1.5 d	8.2	5.9						4130 070 6006	4132 070 6006
		2 d	11.0	8.3						4130 070 6008	4132 070 6008
		2.5 d	13.7	10.7						4130 070 6010	4132 070 6010
1/4"-20	1.270	1 d	6.4	3.4	8.0 8.4	6.62 6.86	6.7	5.8 8.9 12.1 15.3	8.00	4130 074 6004	4132 074 6004
		1.5 d	9.5	5.7						4130 074 6006	4132 074 6006
		2 d	12.7	8.0						4130 074 6008	4132 074 6008
		2.5 d	15.9	10.3						4130 074 6010	4132 074 6010
5/16"-18	1.411	1 d	7.9	4.0	9.7 10.2	8.24 8.49	8.4	7.2 11.2 15.2 19.1	9.77	4130 076 6004	4132 076 6004
		1.5 d	11.9	6.6						4130 076 6006	4132 076 6006
		2 d	15.9	9.3						4130 076 6008	4132 076 6008
		2.5 d	19.8	11.9						4130 076 6010	4132 076 6010
3/8"-16	1.588	1 d	9.5	4.4	11.5 12.0	9.89 10.12	10.0	8.7 13.5 18.3 23.0	11.59	4130 077 6004	4132 077 6004
		1.5 d	14.3	7.2						4130 077 6006	4132 077 6006
		2 d	19.1	10.1						4130 077 6008	4132 077 6008
		2.5 d	23.8	12.9						4130 077 6010	4132 077 6010

*Other lengths on request.

① see flap page 17 b

Thread inserts **HELICOIL® Plus** – UNC/NC = American National Coarse threads

d	P	t ₂ min.*		W	d ₁ min. max.	D _{1HC} min. max.	B	t ₃ max.	D _{HC} min.	Free Running Item No ①	Screwlock Item No ①
		x d	mm								
7/16"-14	1.814	1 d	11.1	4.5	13.4	11.51	11.6	10.2	13.47	4130 078 6004	4132 078 6004
		1.5 d	16.7	7.4						4130 078 6006	4132 078 6006
		2 d	22.2	10.3						4130 078 6008	4132 078 6008
		2.5 d	27.8	13.1						4130 078 6010	4132 078 6010
1/2"-13	1.954	1 d	12.7	4.8	15.2	13.12	13.2	11.7	15.24	4130 079 6004	4132 079 6004
		1.5 d	19.1	7.9						4130 079 6006	4132 079 6006
		2 d	25.4	10.9						4130 079 6008	4132 079 6008
		2.5 d	31.8	13.9						4130 079 6010	4132 079 6010

 Thread inserts **HELICOIL® Classic** – UNC/NC = American National Coarse threads

9/16"-12	2.117	1 d	14.3	5.1	17.0	14.75	14.9	13.2	17.04	0130 080 6004	0132 080 6004
		1.5 d	21.5	8.3						0130 080 6006	0132 080 6006
		2 d	28.6	11.5						0130 080 6008	0132 080 6008
		2.5 d	35.7	14.7						0130 080 6010	0132 080 6010
5/8"-11	2.309	1 d	15.9	5.3	18.9	16.38	16.6	14.7	18.88	0130 081 6004	0132 081 6004
		1.5 d	23.8	8.3						0130 081 6006	0132 081 6006
		2 d	31.8	11.8						0130 081 6008	0132 081 6008
		2.5 d	39.7	15.0						0130 081 6010	0132 081 6010
3/4"-10	2.540	1 d	19.1	5.9	22.4	19.60	19.7	17.8	22.35	0130 083 6004	0132 083 6004
		1.5 d	28.6	9.4						0130 083 6006	0132 083 6006
		2 d	38.1	13.0						0130 083 6008	0132 083 6008
		2.5 d	47.6	16.6						0130 083 6010	0132 083 6010
7/8"-9	2.822	1 d	22.2	6.3	26.0	22.84	23.0	20.8	25.89	0130 085 6004	–
		1.5 d	33.3	10.0						0130 085 6006	–
		2 d	44.5	13.7						0130 085 6008	–
		2.5 d	55.6	17.4						0130 085 6010	–
1"-8	3.175	1 d	25.4	6.4	29.6	26.09	26.2	23.8	29.53	0130 086 6004	–
		1.5 d	38.1	10.2						0130 086 6006	–
		2 d	50.8	14.0						0130 086 6008	–
		2.5 d	63.5	17.8						0130 086 6010	–
1 1/8"-7	3.629	1 d	28.6	6.3	33.4	29.36	29.5	26.8	33.29	0130 087 6004	–
		1.5 d	42.9	10.0						0130 087 6006	–
		2 d	57.2	13.8						0130 087 6008	–
		2.5 d	–	–						0130 087 6010	–
1 1/4"-7	3.629	1 d	31.8	7.1	36.7	32.54	33.0	30.0	36.46	0130 088 6004	–
		1.5 d	47.6	11.3						0130 088 6006	–
		2 d	63.5	15.4						0130 088 6008	–
		2.5 d	–	–						0130 088 6010	–
1 3/8"-6	4.234	1 d	34.9	6.6	40.6	35.84	36.0	32.8	40.42	0130 089 6004	–
		1.5 d	52.4	10.6						0130 089 6006	–
		2 d	69.9	14.4						0130 089 6008	–
		2.5 d	–	–						0130 089 6010	–
1 1/2"-6	4.234	1 d	38.1	7.4	43.9	39.02	39.5	36.0	43.60	0130 090 6004	–
		1.5 d	57.2	11.6						0130 090 6006	–
		2 d	76.2	15.9						0130 090 6008	–
		2.5 d	–	–						0130 090 6010	–

*Other lengths on request.

① see flap page 17 b

Thread inserts **HELICOIL® Plus** – UNF/NF = American National Fine threads

d	P	t ₂ min.*		W	d ₁ min. max.	D _{1HC} min. max.	B	t ₃ max.	D _{HC} min.	Free Running Item No ①	Screwlock Item No ①
		x d	mm								
4-48	0.529	1 d	2.8	3.4	3.7 4.1	2.97 3.12	3.0	2.5	3.53	4130 065 7004	4132 065 7004
		1.5 d	4.3	5.6				4.0		4130 065 7006	4132 065 7006
		2 d	5.7	7.9				5.4		4130 065 7008	4132 065 7008
		2.5 d	7.1	10.3				6.7		4130 065 7010	4132 065 7010
6-40	0.635	1 d	3.5	3.6	4.5 4.9	3.66 3.81	3.8	3.1	4.33	4130 067 7004	4132 067 7004
		1.5 d	5.3	6.0				4.9		4130 067 7006	4132 067 7006
		2 d	7.0	8.4				6.6		4130 067 7008	4132 067 7008
		2.5 d	8.8	10.8				8.4		4130 067 7010	4132 067 7010
8-36	0.706	1 d	4.2	4.0	5.3 5.7	4.32 4.47	4.4	3.8	5.08	4130 068 7004	4132 068 7004
		1.5 d	6.3	6.6				5.9		4130 068 7006	4132 068 7006
		2 d	8.3	9.1				7.9		4130 068 7008	4132 068 7008
		2.5 d	10.5	11.7				10.1		4130 068 7010	4132 068 7010
10-32	0.794	1 d	4.8	4.1	6.1 6.5	5.00 5.16	5.1	4.4	5.86	4130 069 7004	4132 069 7004
		1.5 d	7.2	6.8				6.8		4130 069 7006	4132 069 7006
		2 d	9.6	9.5				9.2		4130 069 7008	4132 069 7008
		2.5 d	12.1	12.1				11.7		4130 069 7010	4132 069 7010
1/4"-28	0.907	1 d	6.4	5.0	7.8 8.3	6.55 6.72	6.7	5.9	7.53	4130 074 7004	4132 074 7004
		1.5 d	9.5	8.1				9.0		4130 074 7006	4132 074 7006
		2 d	12.7	11.3				12.2		4130 074 7008	4132 074 7008
		2.5 d	15.9	14.4				15.4		4130 074 7010	4132 074 7010
5/16"-24	1.058	1 d	7.9	5.5	9.7 10.2	8.17 8.35	8.2	7.4	9.31	4130 076 7004	4132 076 7004
		1.5 d	11.9	8.9				11.4		4130 076 7006	4132 076 7006
		2 d	15.9	12.2				15.4		4130 076 7008	4132 076 7008
		2.5 d	19.8	15.6				19.3		4130 076 7010	4132 076 7010
3/8"-24	1.058	1 d	9.5	6.9	11.4 11.9	9.75 9.93	9.8	9.0	10.90	4130 077 7004	4132 077 7004
		1.5 d	14.3	10.9				13.8		4130 077 7006	4132 077 7006
		2 d	19.1	14.9				18.6		4130 077 7008	4132 077 7008
		2.5 d	23.8	19.0				23.3		4130 077 7010	4132 077 7010
7/16"-20	1.270	1 d	11.1	6.6	13.4 13.9	11.39 11.59	11.5	10.5	12.76	4130 078 7004	4132 078 7004
		1.5 d	16.7	10.6				16.1		4130 078 7006	4132 078 7006
		2 d	22.2	14.5				21.6		4130 078 7008	4132 078 7008
		2.5 d	27.8	18.4				27.2		4130 078 7010	4132 078 7010
1/2"-20	1.270	1 d	12.7	7.8	15.1 15.7	12.97 13.16	13.1	12.1	14.35	4130 079 7004	4132 079 7004
		1.5 d	19.1	12.3				18.5		4130 079 7006	4132 079 7006
		2 d	25.4	16.8				24.8		4130 079 7008	4132 079 7008
		2.5 d	31.8	21.3				31.2		4130 079 7010	4132 079 7010

*Other lengths on request.

① see flap page 17 b

Thread inserts **HELICOIL® Classic** – UNF/NF = American National Fine threads

d	P	t ₂ min.*		W	d ₁ min. max.	D _{1HC} min. max.	B	t ₃ max.	D _{HC} min.	Free Running Item No ①	Screwlock Item No ①
		x d	mm								
9/16"-18	1.411	1 d	14.3	7.9	16.9 17.6	14.59 14.79	14.7	13.6	16.12	0130 080 7004	0132 080 7004
		1.5 d	21.5	12.5				20.8		0130 080 7006	0132 080 7006
		2 d	28.6	17.1				27.9		0130 080 7008	0132 080 7008
		2.5 d	35.7	21.6				35.0		0130 080 7010	0132 080 7010
5/8"-18	1.411	1 d	15.9	8.9	18.6 19.3	16.18 16.38	16.3	15.2	17.71	0130 081 7004	0132 081 7004
		1.5 d	23.8	14.1				23.1		0130 081 7006	0132 081 7006
		2 d	31.8	19.1				31.1		0130 081 7008	0132 081 7008
		2.5 d	39.7	24.3				39.0		0130 081 7010	0132 081 7010
3/4"-16	1.588	1 d	19.1	9.7	22.2 22.9	19.39 19.60	19.5	18.3	21.11	0130 083 7004	0132 083 7004
		1.5 d	28.6	15.1				27.8		0130 083 7006	0132 083 7006
		2 d	38.1	20.6				37.3		0130 083 7008	0132 083 7008
		2.5 d	47.7	26.0				46.9		0130 083 7010	0132 083 7010
7/8"-14	1.814	1 d	22.2	9.9	26.0 26.7	22.62 22.84	22.7	21.3	24.58	0130 085 7004	–
		1.5 d	33.3	15.4				32.4		0130 085 7006	–
		2 d	44.5	21.0				43.6		0130 085 7008	–
		2.5 d	55.6	26.6				54.7		0130 085 7010	–
1"-14	1.814	1 d	25.4	11.5	29.4 30.1	25.86 26.11	26.0	24.5	27.76	0130 086 9004	–
		1.5 d	38.1	17.9				37.2		0130 086 9006	–
		2 d	50.8	24.3				49.9		0130 086 9008	–
		2.5 d	63.5	30.6				62.6		0130 086 9010	–
1"-12	2.117	1 d	25.4	9.7	29.7 30.4	25.86 26.11	26.0	24.3	28.15	0130 086 7004	–
		1.5 d	38.1	15.1				37.0		0130 086 7006	–
		2 d	50.8	20.6				49.7		0130 086 7008	–
		2.5 d	63.5	26.1				62.4		0130 086 7010	–
1 1/8"-12	2.117	1 d	28.6	10.1	33.2 33.9	29.03 29.29	29.0	27.5	31.33	0130 087 7004	–
		1.5 d	42.9	17.3				41.8		0130 087 7006	–
		2 d	57.2	23.4				56.1		0130 087 7008	–
		2.5 d	–	–				–		0130 087 7010	–
1 1/4"-12	2.117	1 d	31.8	12.4	36.6 37.3	32.21 32.46	32.5	30.7	34.50	0130 088 7004	–
		1.5 d	47.6	19.3				46.5		0130 088 7006	–
		2 d	63.5	26.1				62.4		0130 088 7008	–
		2.5 d	–	–				–		0130 088 7010	–
1 3/8"-12	2.117	1 d	34.9	13.8	40.0 40.9	35.38 35.63	35.5	33.8	37.68	0130 089 7004	–
		1.5 d	52.4	21.3				51.3		0130 089 7006	–
		2 d	69.9	28.9				68.8		0130 089 7008	–
		2.5 d	–	–				–		0130 089 7010	–
1 1/2"-12	2.117	1 d	38.1	15.2	43.4 44.3	38.56 38.81	38.5	37.0	40.85	0130 090 7004	–
		1.5 d	57.2	23.4				56.1		0130 090 7006	–
		2 d	76.2	31.6				75.1		0130 090 7008	–
		2.5 d	–	–				–		0130 090 7010	–

*Other lengths on request.

① see flap page 17 b

Thread inserts **HELICOIL® Classic** – BSW = British Standard Whitworth threads

d	P	t ₂ min.*		W	d ₁ min. max.	D _{1HC} min. max.	B	t ₃ max.	D _{HC} min.	Free Running Item No **	Screwlock Item No **
		x d	mm								
1/8"-40	0.635	1.5 d	4.8	5.6	4.0 4.4	3.28 3.43	3.4	4.4	3.93	A71100252202	-
		2 d	6.4	7.9				6.0		A71100252203	-
		3 d	9.5	12.4				8.9		A71100252205	-
3/16"-24	1.058	1 d	4.8	2.9	6.1 6.5	4.98 5.13	5.1	4.3	6.01	A71100252301	-
		1.5 d	7.1	5.1				6.6		A71100252302	-
		2 d	9.6	6.1				9.1		A71100252303	-
		2.5 d	11.9	9.3				11.4		A71100252304	-
		3 d	14.3	11.4				13.2		A71100252305	-
1/4"-20	1.270	1 d	6.4	3.4	7.9 8.4	6.63 6.78	6.7	5.8	7.84	A71100252401	A71130258501
		1.5 d	9.5	5.9				8.9		A71100252402	A71130258502
		2 d	12.7	8.1				12.1		A71100252403	A71130258503
		2.5 d	15.9	10.5				15.3		A71100252404	A71130258504
		3 d	19.1	13.0				17.8		A71100252405	-
5/16"-18	1.411	1 d	7.9	4.1	9.7 10.2	8.33 8.48	8.5	7.2	9.59	A71100252501	-
		1.5 d	11.9	6.7				11.2		A71100252502	-
		2 d	15.9	9.4				15.2		A71100252503	-
		2.5 d	19.8	12.0				19.1		A71100252504	-
		3 d	23.8	14.8				22.4		A71100252505	-
3/8"-16	1.588	1 d	9.5	4.5	11.5 12.0	9.91 10.11	10.0	8.7	11.39	A71100252601	-
		1.5 d	14.3	7.3				13.5		A71100252602	-
		2 d	19.1	10.2				18.3		A71100252603	-
		2.5 d	23.8	13.0				23.0		A71100252604	-
		3 d	28.6	15.8				27.0		A71100252605	-
7/16"-14	1.814	1 d	11.1	4.6	13.5 14.0	11.51 11.76	11.6	10.2	13.24	A71100252701	-
		1.5 d	16.7	7.5				15.8		A71100252702	-
		2 d	22.2	10.4				21.3		A71100252703	-
		2.5 d	27.8	13.3				26.9		A71100252704	-
		3 d	33.3	16.0				31.5		A71100252705	-
1/2"-12	2.117	1 d	12.7	4.4	15.4 16.0	13.08 13.34	13.2	11.6	15.17	A71100252801	-
		1.5 d	19.1	7.3				18.0		A71100252802	-
		2 d	25.4	10.1				24.3		A71100252803	-
		2.5 d	31.8	13.0				30.7		A71100252804	-
		3 d	38.1	16.7				36.0		A71100252805	-
9/16"-12	2.117	1 d	14.3	5.2	17.0 17.6	14.68 14.94	14.8	13.2	16.76	A71100252901	-
		1.5 d	21.5	8.4				20.4		A71100252902	-
		2 d	28.6	11.6				27.5		A71100252903	-
		2.5 d	35.7	14.8				34.6		A71100252904	-
		3 d	42.8	17.9				40.7		A71100252905	-
5/8"-11	2.309	1 d	15.9	5.4	18.9 19.5	16.59 16.84	16.7	14.7	18.57	A71100253001	-
		1.5 d	23.8	8.7				22.6		A71100253002	-
		2 d	31.8	11.9				30.6		A71100253003	-
		2.5 d	39.7	15.3				38.5		A71100253004	-
		3 d	47.6	18.4				45.3		A71100253005	-
11/16"-11	2.309	1.5 d	26.2	9.7	20.5 21.1	18.21 18.47	18.3	25.0	20.16	A71100253102	-
		2 d	34.9	13.3				33.7		A71100253103	-

*Other lengths on request.

** Used material stainless steel A2. Stainless steel A4 on request.

Thread inserts **HELICOIL® Classic** – BSW = British Standard Whitworth threads

d	P	t ₂ min.*		W	d ₁ min. max.	D _{1HC} min. max.	B	t ₃ max.	D _{HC} min.	Free Running Item No **	Screwlock Item No **
		x d	mm								
3/4"-10	2.540	1 d	19.1	6.0	22.4 23.0	19.84 20.09	20.0	17.8	22.02	A71100253201	A71130404901
		1.5 d	28.6	9.6				27.3		A71100253202	A71130404902
		2 d	38.1	13.2				36.8		A71100253203	A71130404903
		2.5 d	47.6	16.8				46.3		A71100253204	A71130404904
		3 d	57.2	23.3				54.6		A71100253205	A71130404905
7/8"-9	2.822	1 d	22.2	6.4	26.0 26.7	23.01 23.27	23.0	20.8	25.52	A71100253301	–
		1.5 d	33.3	10.1				31.9		A71100253302	–
		2 d	44.5	13.9				43.1		A71100253303	–
		2.5 d	55.6	17.7				54.2		A71100253304	–
		3 d	66.8	21.3				63.9		A71100253305	–
1"-8	3.175	1 d	25.4	6.5	27.7 30.4	26.19 26.52	26.5	23.8	29.10	A71100253401	A71130276401
		1.5 d	38.1	10.3				36.5		A71100253402	A71130276402
		2 d	50.8	14.1				49.2		A71100253403	A71130276403
		2.5 d	63.5	17.9				61.9		A71100253404	A71130276404
		3 d	76.2	21.8				73.0		A71100253405	A71130276405
1 1/8"-7	3.629	1 d	28.6	6.4	33.5 34.4	29.74 30.12	30.0	26.8	32.80	A71100253501	–
		1.5 d	42.9	10.1				41.1		A71100253502	–
		2 d	57.2	13.9				55.4		A71100253503	–
		2.5 d	–	–				–		A71100253504	–
1 1/4"-7	3.629	2 d	63.5	15.6	36.7 37.7	32.92 33.30	33.0	61.7	35.97	A71100253612	–
1 1/2"-6	4.233	2 d	76.2	16.1	43.9 45.1	39.27 39.90	39.5	74.1	43.02	A71100253810	–
		2.5 d	–	–				–		A71100253806	–

*Other lengths on request.

** Used material stainless steel A2. Stainless steel A4 on request.

Thread inserts **HELICOIL® Classic** – BSF = British Standard Fine threads

d	P	t ₂ min.*		W	d ₁ min. max.	D _{1HC} min. max.	B	t ₃ max.	D _{HC} min.	Free Running Item No**	Screwlock Item No**
		x d	mm								
3/16"-32	0.794	1 d	4.8	4.1	6.0 6.4	4.88 5.03	5.0	4.4	5.71	A71100249901	A71130256601
		1.5 d	7.1	6.8				6.7		A71100249902	A71130256602
		2 d	9.5	9.4				9.1		A71100249903	A71130256603
		2.5 d	11.9	12.1				11.5		-	A71130256604
		3 d	14.3	14.7				13.5		-	A71130256605
7/32"-28	0.907	1.5 d	8.3	7.0	7.0 7.4	5.72 5.87	5.8	7.8	6.63	A71100250002	-
1/4"-26	0.977	1 d	6.4	4.6	7.9 8.4	6.53 6.71	6.6	5.9	7.51	A71100250101	A71130256801
		1.5 d	9.5	7.6				9.0		A71100250102	A71130256802
		2 d	12.7	10.4				12.2		A71100250103	A71130256803
		2.5 d	15.9	13.4				15.4		A71100250104	A71130256804
		3 d	19.1	16.1				18.1		A71100250105	A71130256805
9/32"-26	0.977	1 d	7.1	5.4	8.7 9.2	7.32 7.49	7.4	6.6	8.31	A71100250201	A71130256901
		1.5 d	10.7	8.7				10.2		A71100250202	A71130256902
5/16"-22	1.155	1 d	7.9	5.0	9.8 10.3	8.20 8.38	8.3	7.3	9.30	A71100250301	A71130257001
		1.5 d	11.9	8.1				11.3		A71100250302	A71130257002
		2 d	15.9	11.2				15.3		A71100250303	A71130257003
		2.5 d	19.8	14.3				19.2		A71100250304	A71130257004
		3 d	23.8	17.3				22.7		A71100250305	A71130257005
3/8"-20	1.270	1 d	9.5	5.6	11.6 12.1	9.78 9.96	9.9	8.8	11.02	A71100250401	A71130257101
		1.5 d	14.3	9.0				13.6		A71100250402	A71130257102
		2 d	19.1	12.4				18.4		A71100250403	A71130257103
		2.5 d	23.8	15.8				23.1		A71100250404	A71130257104
		3 d	28.6	19.1				27.3		A71100250405	A71130257105
7/16"-18	1.411	1 d	11.1	5.9	13.6 14.1	11.43 11.63	11.5	10.4	12.78	A71100250501	-
		1.5 d	16.7	9.5				16.0		A71100250502	-
		2 d	22.2	13.1				21.5		A71100250503	-
		2.5 d	27.8	16.6				27.1		A71100250504	-
		3 d	33.3	20.0				31.9		A71100250505	-
1/2"-16	1.588	1 d	12.7	6.1	15.5 16.0	13.03 13.26	13.1	11.9	14.57	A71100250601	-
		1.5 d	19.1	9.7				18.3		A71100250602	A71130257302
		2 d	25.4	13.3				24.6		A71100250603	-
		2.5 d	31.8	16.9				31.0		A71100250604	-
		3 d	31.8	20.4				36.5		A71100250605	-
9/16"-16	1.588	1.5 d	21.5	11.1	17.2 17.8	14.66 14.88	14.8	20.7	16.16	A71100250702	-
5/8"-14	1.814	1 d	15.9	6.8	19.1 19.7	16.26 16.49	16.4	15.0	18.01	A71100250801	A71130257501
		1.5 d	23.8	10.8				22.9		A71100250802	A71130257502
		2 d	31.8	14.8				30.9		A71100250803	A71130257503
		2.5 d	39.7	18.7				38.8		A71100250804	A71130257504
		3 d	47.6	22.6				45.8		A71100250805	A71130257505

*Other lengths on request.

** Used material stainless steel A2. Stainless steel A4 on request.

Thread inserts **HELICOIL® Classic** – BSF = British Standard Fine threads

d	P	t ₂ min.*		W	d ₁ min. max.	D _{1HC} min. max.	B	t ₃ max.	D _{HC} min.	Free Running Item No**	Screwlock Item No**
		x d	mm								
11/16"-14	1.814	1.5 d	26.2	11.9	20.8 21.4	17.86 18.11	18.0	25.3	19.60	A71100250902	–
3/4"-12	2.117	1 d	19.1	7.0	22.9 23.5	19.43 19.69	19.5	18.0	21.53	A71100251001	–
		1.5 d	28.6	11.1				27.5		A71100251002	–
		2 d	38.1	15.2				37.0		A71100251003	–
		2.5 d	47.6	19.3				46.5		A71100251004	–
		3 d	57.2	23.3				55.0		A71100251005	–
13/16"-12	2.117	1.5 d	30.9	12.1	24.6 25.2	21.03 21.29	21.2	29.9	23.12	A71100251102	–
7/8"-11	2.309	1 d	22.2	7.6	26.5 27.3	22.61 22.86	22.7	21.0	24.94	A71100251201	–
		1.5 d	33.3	11.9				32.1		A71100251202	–
		2 d	44.5	16.4				43.3		A71100251203	–
		2.5 d	55.6	20.8				54.4		A71100251204	–
		3 d	66.7	25.0				64.4		A71100251205	–
1"-10	2.540	1 d	25.4	7.9	30.2 31.0	26.19 26.52	26.5	24.1	28.38	A71100251301	–
		1.5 d	38.1	12.5				36.8		A71100251302	–
		2 d	50.8	17.1				49.5		A71100251303	–
1 1/8"-9	2.822	1 d	28.6	8.1	33.9 34.7	39.36 29.72	29.5	27.2	31.88	A71100251401	–
		1.5 d	42.9	12.7				41.5		A71100251402	–
		2 d	57.2	17.3				55.8		A71100251403	–
		2.5 d	–	–				–		A71100251404	–
1 1/4"-9	2.822	1 d	31.8	9.1	37.3 38.1	32.54 32.89	32.5	30.4	35.06	A71100251501	–
		1.5 d	47.6	14.3				46.2		A71100251502	–
		2 d	63.5	19.4				62.1		A71100251503	–
		2.5 d	–	–				–		A71100251504	–
1 3/8"-8	3.175	1.5 d	52.4	13.9	41.2 42.1	35.71 36.07	36.0	50.8	38.64	A71100251602	–
		2 d	69.9	18.9				68.3		A71100251603	–
1 1/2"-8	3.175	1 d	38.1	9.8	44.6 45.5	38.89 39.24	39.0	36.5	41.82	A71100251701	–
		1.5 d	57.2	15.3				55.6		A71100251702	–
		2 d	76.2	20.8				74.6		A71100251703	–

*Other lengths on request.

** Used material stainless steel A2. Stainless steel A4 on request.

Thread inserts **HELICOIL® Plus** – ISO 228/1 Pipe threads **

d	P	t ₂ min.*		W	d ₁ min. max.	D _{1HC} min. max.	B	t ₃ max.	D _{HC} min.	Free Running Item No ①	Screwlock Item No ①
		x d	mm								
G 1/8"-28	0.907	1 d	3.2	1.9	11.5	9.91	10.0	2.7	10.82	4130 071 4004	–
		1.5 d	4.8	3.6				4.3		4130 071 4006	–
		2 d	6.4	5.1				5.9		4130 071 4008	–
		2.5 d	7.9	6.6				7.4		4130 071 4010	–
G 1/4"-19	1.337	1 d	6.4	3.1	15.7	13.46	13.6	5.7	14.74	4130 074 4004	–
		1.5 d	9.5	5.3				8.8		4130 074 4006	–
		2 d	12.7	7.4				12.0		4130 074 4008	–
		2.5 d	15.9	9.6				15.2		4130 074 4010	–
G 3/8"-19	1.337	1 d	9.5	5.3	19.5	17.02	17.1	8.8	18.25	4130 077 4004	–
		1.5 d	14.3	8.5				13.6		4130 077 4006	–
		2 d	19.1	11.8				18.4		4130 077 4008	–
		2.5 d	23.8	15.0				23.1		4130 077 4010	–
G 1/2"-14	1.814	1 d	12.7	5.2	24.6	21.34	21.5	11.7	23.09	4130 079 4004	–
		1.5 d	19.1	8.4				18.1		4130 079 4006	–
		2 d	25.4	11.6				24.6		4130 079 4008	–
		2.5 d	31.8	14.8				30.8		4130 079 4010	–

Thread inserts **HELICOIL® Classic** – ISO 228/1 Pipe threads **

G 5/8"-14	1.814	1 d	15.9	6.8	26.7	23.24	23.4	14.9	25.05	0130 081 4004	–
		1.5 d	23.8	10.8				22.8		0130 081 4006	–
		2 d	31.8	14.8				30.8		0130 081 4008	–
		2.5 d	39.7	18.8				38.7		0130 081 4010	–
G 3/4"-14	1.814	1 d	19.1	8.4	30.5	26.75	27.0	18.1	28.59	0130 083 4004	–
		1.5 d	28.6	13.3				27.6		0130 083 4006	–
		2 d	38.1	18.1				37.1		0130 083 4008	–
		2.5 d	47.6	22.9				46.6		0130 083 4010	–
G 7/8"-14	1.814	1 d	22.2	10.0	34.6	30.48	30.6	21.2	32.35	0130 085 4004	–
		1.5 d	33.3	15.6				32.3		0130 085 4006	–
		2 d	44.5	21.3				43.5		0130 085 4008	–
		2.5 d	–	–				–		0130 085 4010	–
G 1"-11	2.309	1 d	25.4	8.9	38.4	33.53	33.7	24.3	35.96	0130 086 4004	–
		1.5 d	38.1	13.9				37.0		0130 086 4006	–
		2 d	50.8	19.0				49.7		0130 086 4008	–
		2.5 d	–	–				–		0130 086 4010	–
G 1 1/4"-11	2.309	1 d	31.8	11.4	47.7	42.29	42.5	30.7	44.63	0130 088 4004	–
		1.5 d	47.6	17.8				46.5		0130 088 4006	–
		2 d	63.5	24.1				62.4		0130 088 4008	–
		2.5 d	–	–				–		0130 088 4010	–
G 1 1/2"-11	2.309	1 d	38.1	13.9	54.1	48.41	48.5	37.0	50.53	0130 090 4004	–
		1.5 d	57.2	21.6				56.1		0130 090 4006	–
		2 d	–	–				–		0130 090 4008	–
		2.5 d	–	–				–		0130 090 4010	–

*Other lengths on request.

**G ≙ BSP (British Standard Pipe thread)

① see flap page 17b

Thread inserts **HELICOIL® Classic** – BA = British Association Standard threads

d	P	t ₂ min.*		W	d ₁ min. max.	D _{1HC} min. max.	B	t ₃ max.	D _{HC} min.	Free Running Item No**	Screwlock Item No**
		x d	mm								
0 BA	1.00	1 d	6.0	4.3	7.4	6.12	6.2	5.5	7.12	A71100254901	A71130281101
		1.5 d	9.0	6.9				8.5		A71100254902	A71130281102
		2 d	12.0	9.6				11.5		A71100254903	A71130281103
		2.5 d	15.0	12.3				14.5		A71100254904	A71130281104
1 BA	0.90	1 d	5.3	4.1	6.5	5.41	5.5	4.8	6.31	A71100255001	–
2 BA	0.81	1 d	4.7	4.0	5.8	4.85	4.9	4.3	5.61	A71100255101	A71130281301
		1.5 d	7.1	6.6				6.7		A71100255102	A71130281302
		2 d	9.4	9.0				9.0		A71100255103	A71130281303
		2.5 d	11.8	11.7				11.4		A71100255104	A71130281304
3 BA	0.73	1 d	4.1	3.9	5.1	4.22	4.3	3.7	4.92	A71100255201	–
		1.5 d	6.2	6.3				5.8		A71100255202	–
		2 d	8.2	8.8				7.8		A71100255203	–
		2.5 d	10.3	11.3				9.9		A71100255204	–
4 BA	0.66	1 d	3.6	3.7	4.5	3.73	3.8	3.3	4.35	A71100255301	A71130281501
		1.5 d	5.4	6.1				5.1		A71100255302	A71130281502
		2 d	7.2	8.4				6.9		A71100255303	A71130281503
		2.5 d	9.0	10.9				8.7		A71100255304	A71130281504
5 BA	0.59	1 d	3.2	3.6	4.0	3.28	3.3	2.9	3.87	A71100255401	–
		1.5 d	4.8	6.0				4.5		A71100255402	–
		2 d	6.4	8.4				6.1		A71100255403	–
		2.5 d	8.0	10.8				7.7		A71100255404	–
6 BA	0.53	1 d	2.8	3.5	3.6	2.87	2.9	2.5	3.40	A71100255501	A71130281701
		1.5 d	4.2	5.8				3.9		A71100255502	A71130281702
		2 d	5.6	8.0				5.3		A71100255503	A71130281703
		2.5 d	7.0	10.3				6.7		A71100255504	A71130281704

*Other lengths on request.

** Used material stainless steel A2. Stainless steel A4 on request.

HELICOIL® Plus STRIPFEED®

Magazined thread inserts for efficient installation



For accessories see page 56

**UNC/NC =
American
National Coarse
threads**

Thread nominal Ø	Nominal length	Magazined with roller diameter = 320 mm			Magazined with roller diameter = 220 mm		
		Number of inserts	HELICOIL® Plus Free Running Item No	HELICOIL® Plus Screwlock Item No	Number of inserts	HELICOIL® Plus Free Running Item No	HELICOIL® Plus Screwlock Item No
2-56	1 x d	5000	4130 763 6004	4132 763 6004	1000	4130 763 6024*	4132 763 6024*
	1.5 x d	4000	4130 763 6006	4132 763 6006	1000	4130 763 6026*	4132 763 6026*
	2 x d	3000	4130 763 6008	4132 763 6008	1000	4130 763 6028*	4132 763 6028*
	2.5 x d	*	4130 763 6010	4132 763 6010	1000	*	*
4-40	1 x d	4000	4130 765 6004	4132 765 6004	1000	4130 765 6024*	4132 765 6024*
	1.5 x d	2500	4130 765 6006	4132 765 6006	1000	4130 765 6026*	4132 765 6026*
	2 x d	2300	4130 765 6008	4132 765 6008	1000	4130 765 6028*	4132 765 6028*
	2.5 x d	1800	4130 765 6010	4132 765 6010	1000	*	*
5-40	1 x d	3500	4130 766 6004	4132 766 6004	1000	4130 766 6024*	4132 766 6024*
	1.5 x d	2800	4130 766 6006	4132 766 6006	1000	4130 766 6026*	4132 766 6026*
	2 x d	2000	4130 766 6008	4132 766 6008	1000	4130 766 6028*	4132 766 6028*
	2.5 x d	1650	4130 766 6010	4132 766 6010	1000	*	*
6-32	1 x d	2500	4130 767 6004	4132 767 6004	1000	4130 767 6024*	4132 767 6024*
	1.5 x d	1500	4130 767 6006	4132 767 6006	1000	4130 767 6026*	4132 767 6026*
	2 x d	1400	4130 767 6008	4132 767 6008	1000	4130 767 6028*	4132 767 6028*
	2.5 x d	1350	4130 767 6010	4132 767 6010	1000	*	*
8-32	1 x d	2000	4130 768 6004	4132 768 6004	1000	4130 768 6024*	4132 768 6024*
	1.5 x d	1400	4130 768 6006	4132 768 6006	1000	4130 768 6026*	4132 768 6026*
	2 x d	1100	4130 768 6008	4132 768 6008	1000	4130 768 6028*	4132 768 6028*
	2.5 x d	850	4130 768 6010	4132 768 6010	1000	*	*
10-24	1 x d	1500	4130 769 6004	4132 769 6004	1000	4130 769 6024*	4132 769 6024*
	1.5 x d	1000	4130 769 6006	4132 769 6006	1000	4130 769 6026*	4132 769 6026*
	2 x d	800	4130 769 6008	4132 769 6008	1000	4130 769 6028*	4132 769 6028*
	2.5 x d	650	4130 769 6010	4132 769 6010	1000	*	*
12-24	1 x d	1450	4130 770 6004	4132 770 6004	1000	4130 770 6024*	4132 770 6024*
	1.5 x d	950	4130 770 6006	4132 770 6006	1000	4130 770 6026*	4132 770 6026*
	2 x d	700	4130 770 6008	4132 770 6008	1000	4130 770 6028*	4132 770 6028*
	2.5 x d	500	4130 770 6010	4132 770 6010	1000	*	*
1/4"-20	1 x d	1000	4130 774 6004	4132 774 6004	1000	4130 774 6024*	4132 774 6024*
	1.5 x d	650	4130 774 6006	4132 774 6006	1000	4130 774 6026*	4132 774 6026*
	2 x d	500	4130 774 6008	4132 774 6008	1000	4130 774 6028*	4132 774 6028*
	2.5 x d	400	4130 774 6010	4132 774 6010	1000	*	*
5/16"-18	1 x d	700	4130 776 6004	4132 776 6004	1000	4130 776 6024*	4132 776 6024*
	1.5 x d	400	4130 776 6006	4132 776 6006	1000	4130 776 6026*	4132 776 6026*
	2 x d	300	4130 776 6008	4132 776 6008	1000	4130 776 6028*	4132 776 6028*
	2.5 x d	250	4130 776 6010	4132 776 6010	1000	*	*
3/8"-16	1 x d	400	4130 777 6004	4132 777 6004	1000	4130 777 6024*	4132 777 6024*
	1.5 x d	300	4130 777 6006	4132 777 6006	1000	4130 777 6026*	4132 777 6026*
	2 x d	200	4130 777 6008	4132 777 6008	1000	4130 777 6028*	4132 777 6028*
	2.5 x d	150	4130 777 6010	4132 777 6010	1000	*	*

* On request

Magazined HELICOIL® Plus thread inserts are particularly suitable for processing smaller thread inserts. Manual taps as well as stationary installation devices are also available.

Advantages for processing in small and large scale production:

- High process reliability
- Easier handling
- Improved working conditions for series installation
- Improved performance due to safe feeding
- Cost reduction

Metric dimensions: See separate catalogue No 0100.

HELICOIL® Plus “pick and place” equipment



Installation of HELICOIL® Plus

Thread UNC/NC Nominal Ø	Item No
2-56	*
4-40	*
5-40/6-32	4148 002 0000
8-32/10-24/12-24	4148 004 0000
1/4"-20	4148 006 0000
5/16"-18	4148 008 0000
3/8"-16	4148 008 0000



“pick and place” equipment

HELICOIL® Plus STRIPFEED®

Magazined thread inserts for efficient installation



For accessories see page 56

**UNF/NF =
American
National Fine
threads**

Thread nominal Ø	Nominal length	Magazined with roller diameter = 320 mm			Magazined with roller diameter = 220 mm		
		Number of inserts	HELICOIL® Plus Free Running Item No	HELICOIL® Plus Screwlock Item No	Number of inserts	HELICOIL® Plus Free Running Item No	HELICOIL® Plus Screwlock Item No
4-48	1 x d	4500	4130 765 7004	4132 765 7004	1000	4130 765 7024*	4132 765 7024*
	1.5 x d	3000	4130 765 7006	4132 765 7006	1000	4130 765 7026*	4132 765 7026*
	2 x d	2500	4130 765 7008	4132 765 7008	1000	4130 765 7028*	4132 765 7028*
	2.5 x d	2000	4130 765 7010	4132 765 7010	1000	*	*
6-40	1 x d	2500	4130 767 7004	4132 767 7004	1000	4130 767 7024*	4132 767 7024*
	1.5 x d	1500	4130 767 7006	4132 767 7006	1000	4130 767 7026*	4132 767 7026*
	2 x d	1400	4130 767 7008	4132 767 7008	1000	4130 767 7028*	4132 767 7028*
	2.5 x d	1500	4130 767 7010	4132 767 7010	1000	*	*
8-36	1 x d	2000	4130 768 7004	4132 768 7004	1000	4130 768 7024*	4132 768 7024*
	1.5 x d	1400	4130 768 7006	4132 768 7006	1000	4130 768 7026*	4132 768 7026*
	2 x d	1100	4130 768 7008	4132 768 7008	1000	4130 768 7028*	4132 768 7028*
	2.5 x d	850	4130 768 7010	4132 768 7010	1000	*	*
10-32	1 x d	1500	4130 769 7004	4132 769 7004	1000	4130 769 7024*	4132 769 7024*
	1.5 x d	1000	4130 769 7006	4132 769 7006	1000	4130 769 7026*	4132 769 7026*
	2 x d	800	4130 769 7008	4132 769 7008	1000	4130 769 7028*	4132 769 7028*
	2.5 x d	650	4130 769 7010	4132 769 7010	1000	*	*
1/4"-28	1 x d	1000	4130 774 7004	4132 774 7004	1000	4130 774 7024*	4132 774 7024*
	1.5 x d	650	4130 774 7006	4132 774 7006	1000	4130 774 7026*	4132 774 7026*
	2 x d	500	4130 774 7008	4132 774 7008	1000	4130 774 7028*	4132 774 7028*
	2.5 x d	400	4130 774 7010	4132 774 7010	1000	*	*
5/16"-24	1 x d	700	4130 776 7004	4132 776 7004	1000	4130 776 7024*	4132 776 7024*
	1.5 x d	400	4130 776 7006	4132 776 7006	1000	4130 776 7026*	4132 776 7026*
	2 x d	300	4130 776 7008	4132 776 7008	1000	4130 776 7028*	4132 776 7028*
	2.5 x d	250	4130 776 7010	4132 776 7010	1000	*	*
3/8"-24	1 x d	400	4130 777 7004	4132 777 7004	1000	4130 777 7024*	4132 777 7024*
	1.5 x d	300	4130 777 7006	4132 777 7006	1000	4130 777 7026*	4132 777 7026*
	2 x d	200	4130 777 7008	4132 777 7008	1000	4130 777 7028*	4132 777 7028*
	2.5 x d	150	4130 777 7010	4132 777 7010	1000	*	*

* On request

Magazined HELICOIL® Plus thread inserts are particularly suitable for processing smaller thread inserts. Manual taps as well as stationary installation devices are also available.

Advantages for processing in small and large scale production:

- High process reliability
- Easier handling
- Improved working conditions for series installation
- Improved performance due to safe feeding
- Cost reduction

Metric dimensions: See separate catalogue No 0100.

HELICOIL® Plus “pick and place” equipment



Installation of HELICOIL® Plus

Thread UNF/NF Nominal Ø	Item No
4-48	*
6-40	4148 002 0000
8-36	4148 004 0000
10-32	4148 004 0000
1/4"-28	4148 006 0000
5/16"-24	4148 008 0000
3/8"-24	4148 008 0000



“pick and place” equipment



System modules – the fastener

	Page
Technology	05
Designs	06
A close look at the advantages	08
Modular system	10
Materials	12
Design guidelines	13
Fields of application	14
Installation	16
Technical data and item numbers	18

System modules – the tool

All taps at a glance	34
Thread tolerances for imperial threads	36
Manual taps	38
Machine taps	40
Internal thread gauges	42

Installation

Installation mandrels	46
Installation tools	
Battery installation tools	48
Electrical installation tools	49
Pneumatic installation tools	50
Mechanical installation tools	52
Accessories	56
Automatic installation	57
Manual installation tools	58
Tang break-off and extraction tools	60



All taps at a glance

HELICOIL® Plus manual and machine taps

To tap the HELICOIL® Plus tapped hole, system dependent original HELICOIL® taps must be used. We have suitable manual and machine taps on offer. The overview provides all necessary information.

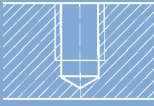
Arrangement	Manual tap Through hole and blind hole	Machine tap		Recommended guide values ^① cutting speed [m/min]*	Cooling/ lubrication
		Through hole 	Blind hole 		
Aluminium and aluminium cast alloys (short-chip)	0140.0 0140.1-2 ^② 0140.3-5 ^③	0141 1XXX XXX	0141 5XXX XXX	10/20	emulsion
Aluminium and aluminium alloys (long-chip)	0140.0 0140.1-2 ^② 0140.3-5 ^③	0141 1XXX XXX	0141 4XXX XXX	15/20	emulsion
Magnesium alloys	0140.0 0140.1-2 ^② 0140.3-5 ^③	0141 1XXX XXX	0141 4XXX XXX	10/20	dry
Steel up to 700 N/mm ² Cast iron soft $R_m \leq 250$ N/mm ² ** Cast iron hard $R_m > 250$ N/mm ² ** Malleable cast iron	0140.0 0140.1-2 ^② 0140.3-5 ^③	0141 1XXX XXX	0141 5XXX XXX	6/15 8/15 6/12 8/12	oil, emulsion petroleum/emulsion emulsion oil, emulsion
Copper Bronze/red brass Brass, tough Zinc alloy	0140.0 0140.1-2 ^② 0140.3-5 ^③	0141 1XXX XXX	0141 5XXX XXX	10/15 5/12 8/16 8/15	oil, emulsion oil, emulsion oil, emulsion oil, emulsion
Brass, brittle	0140.0 0140.1-2 ^② 0140.3-5 ^③	0141 1XXX XXX	0141 5XXX XXX	10/20	oil dry

① In individual cases, preliminary tapping tests are required for other materials.

② Set of taps (two-piece).

③ Set of taps (three-piece).

We also supply TiN-coated taps.

* Smaller value for blind holes, higher value for through holes.

** 1 N/mm² equals 1 MPa

HELICOIL® special machine taps

The standard taps from the HELICOIL® system comply with almost all practical requirements. For critical chip removal requirements, such as materials difficult to machine (stainless and heat-resisting steels, different steel and titanium alloys), we offer special machine taps. The overview provides the machine taps for the respective materials including recommended guide values for cutting speed.

Arrangement	Machine tap		Recommended guide values ^① cutting speed [m/min]*	Cooling/lubrication
	Through hole	Blind hole		
Aluminium alloys with a high silicon content Si > 10%	0141 9XXX 444	0141 9XXX 451	10/20	oil/emulsion
Materials difficult to machine: – Stainless steel – Ferritic/martensitic – Austenitic – Heat-resisting steel	0141 9XXX 444	0141 9XXX 451	3/8 1/4 1/4	oil/emulsion
Hard materials: – Grey cast iron – Spheroidal graphite cast iron	0141 9XXX 418	0141 9XXX 418	8/16 6/12	petroleum/emulsion
Tough, seizing materials: Electrolytic copper Bronze, hard	0141 9XXX 445	0141 9XXX 451	8/12 1/5	oil
Brass, brittle	0141 9XXX 424	0141 9XXX 424	15/25	oil
Titanium alloys: ≤ 700 N/mm ² ** > 700 N/mm ² **	0141 9XXX 444 0141 9XXX 447	0141 9XXX 451 0141 9XXX 432	2/8 1/4	oil
Plastic, soft Thermoplastic	0141 9XXX 445	0141 9XXX 451		compressed air/emulsion
Plastic, brittle Thermoset	0141 9XXX 446	0141 9XXX 446		compressed air

Example of a designation: measurement UNC 6-32: 0141 **9676** 451

Further taps as special versions, such as TiN-coated taps or oversize taps, on request.

* Smaller value for blind holes, higher value for through holes.

** 1 N/mm² equals 1 MPa

Thread tolerances of imperial tapped holes (UNC and UNF)

Standard tolerance

According to NASM 33537, HELICOIL® holding threads comply with tolerance **2B** (medium).

HELICOIL®	Item code – example
Tap	For tolerance classes 2B (medium), the ninth digit of the item code is 1 Example: UNC 6-32 0141 1676 1 04
Threaded plug gauges	For tolerance classes 2B (medium), the ninth digit of the item code is 5 Example: UNC 6-32 0147 3676 5 04

Industry-specific tolerance

Maximum operational reliability and economic efficiency are most important for the development in the aerospace industry. That is why the respective standards demand for tolerance class **3B** (fine), see NASM 33537.

Special HELICOIL® holding threads are not required. Solely the holding thread tolerance class **3B**, widely used in the aerospace industry, is chosen.



Order “The Blue Book”, our catalogue No 0130 for the aerospace industry or download at www.boellhoff.de/the-blue-book.

HELICOIL®	Item code – example
Tap	For tolerance classes 3B (fine), the ninth digit of the item code is 2 Example: UNC 6-32 0141 1676 2 04
Threaded plug gauges	For tolerance classes 3B (fine), the ninth digit of the item code is 4 Example: UNC 6-32 0147 3676 4 04

UNJC and UNJF threads

Bolts with UNJC or UNJF threads according to DIN ISO 3161 can be used with HELICOIL® nut threads.

Special HELICOIL® holding threads are not required. Solely the holding thread tolerance class **3B**, widely used in the aerospace industry, is chosen.

For more than 60 years, the HELICOIL® thread inserts stand for reliable thread reinforcements.



Manual taps for **HELICOIL® Classic** and **HELICOIL® Plus**



Type 0140.0

HELICOIL® manual tap, cutting

4-lead chamfer

For cutting materials with a strength up to 700 N/mm²**.

For through holes.

For blind holes only if sufficient chip space is provided.
Minimum requirement 1 d deeper than the full thread length.



Type 0140.1-2

HELICOIL® manual tap,
two-piece set with tapered lead threads:

Pre-tap 4-lead chamfer 0140.1...
Finishing tap 2-lead chamfer 0140.2...

For cutting materials with a strength up to 700 N/mm²**.

For through holes and blind holes.

** 1 N/mm² equals 1 Mpa

Nominal thread Ø d	Cutting taps for tolerance class 2B* Type 0140.0 Item No	Taps for tolerance class 2B*	
		Pre-taps Type 0140.1 Item No	Finishing taps Type 0140.2 Item No
UNC/NC = American National Coarse threads			
2-56	0140 063 6104	0140 163 6104	0140 263 6102
4-40	0140 065 6104	0140 165 6104	0140 265 6102
5-40	0140 066 6104	0140 166 6104	0140 266 6102
6-32	0140 067 6104	0140 167 6104	0140 267 6102
8-32	0140 068 6104	0140 168 6104	0140 268 6102
10-24	0140 069 6104	0140 169 6104	0140 269 6102
12-24	0140 070 6104	0140 170 6104	0140 270 6102
1/4"-20	0140 074 6104	0140 174 6104	0140 274 6102
5/16"-18	0140 076 6104	0140 176 6104	0140 276 6102
3/8"-16	0140 077 6104	0140 177 6104	0140 277 6102
7/16"-14	0140 078 6104	0140 178 6104	0140 278 6102
1/2"-13	0140 079 6104	0140 179 6104	0140 279 6102
9/16"-12	0140 080 6104	0140 180 6104	0140 280 6102
5/8"-11	0140 081 6104	0140 181 6104	0140 281 6102
3/4"-10	0140 083 6104	0140 183 6104	0140 283 6102
7/8"-9	0140 085 6104	0140 185 6104	0140 285 6102
1"-8	0140 086 6104	0140 186 6104	0140 286 6102
1 1/8"-7	0140 087 6104	0140 187 6104	0140 287 6102
1 1/4"-7	0140 088 6104	0140 188 6104	0140 288 6102
1 3/8"-6	0140 089 6104	0140 189 6104	0140 289 6102
1 1/2"-6	0140 090 6104	0140 190 6104	0140 290 6102
UNF = American National Fine threads			
4-48	0140 065 7104	0140 165 7104	0140 265 7102
6-40	0140 067 7104	0140 167 7104	0140 267 7102
8-36	0140 068 7104	0140 168 7104	0140 268 7102
10-32	0140 069 7104	0140 169 7104	0140 269 7102
1/4"-28	0140 074 7104	0140 174 7104	0140 274 7102
5/16"-24	0140 076 7104	0140 176 7104	0140 276 7102
3/8"-24	0140 077 7104	0140 177 7104	0140 277 7102
7/16"-20	0140 078 7104	0140 178 7104	0140 278 7102
1/2"-20	0140 079 7104	0140 179 7104	0140 279 7102
9/16"-18	0140 080 7104	0140 180 7104	0140 280 7102
5/8"-18	0140 081 7104	0140 181 7104	0140 281 7102
3/4"-16	0140 083 7104	0140 183 7104	0140 283 7102
7/8"-14	0140 085 7104	0140 185 7104	0140 285 7102
1"-14	0140 086 9104	0140 186 9104	0140 286 9102
1"-12	0140 086 7104	0140 186 7104	0140 286 7102
1 1/8"-12	0140 087 7104	0140 187 7104	0140 287 7102
1 1/4"-12	0140 088 7104	0140 188 7104	0140 288 7102
1 3/8"-12	0140 089 7104	0140 189 7104	0140 289 7102
1 1/2"-12	0140 090 7104	0140 190 7104	0140 290 7102

Further sizes upon request.

*For tolerance class 3B the ninth digit of the item code changes from 1 to 2.

Types 0140.0 and 0140.2 can be utilised as machine taps. Shaft diameter tolerance h9.

They are especially suitable for brittle materials such as cast iron, brass and magnesium.

Type 0140.0

HELICOIL® manual tap, cutting

4-lead chamfer

 For cutting materials with a strength up to 700 N/mm²**.

For through holes.

For blind holes only if sufficient chip space is provided.

Minimum requirement 1 d deeper than the full thread length.

Type 0140.1-2

 HELICOIL® manual tap,
two-piece set with tapered lead threads:

Pre-tap 4-lead chamfer 0140.1...

Finishing tap 2-lead chamfer 0140.2...

 For cutting materials with a strength up to 700 N/mm²**.

For through holes and blind holes.

 ** 1 N/mm² equals 1 Mpa

Nominal thread Ø d	Cutting taps for tolerance class 2B* Type 0140.0 Item No	Taps for tolerance class 2B*	
		Pre-taps Type 0140.1 Item No	Finishing taps Type 0140.2 Item No
BSW= British Standard Whitworth threads			
1/8"-40	0140 071 3104	0140 171 3104	0140 271 3102
3/16"-24	0140 072 3104	0140 172 3104	0140 272 3102
1/4"-20	0140 074 3104	0140 174 3104	0140 274 3102
5/16"-18	0140 076 3104	0140 176 3104	0140 276 3102
3/8"-16	0140 077 3104	0140 177 3104	0140 277 3102
7/16"-14	0140 078 3104	0140 178 3104	0140 278 3102
1/2"-12	0140 079 3104	0140 179 3104	0140 279 3102
9/16"-12	0140 080 3104	0140 180 3104	0140 280 3102
5/8"-11	0140 081 3104	0140 181 3104	0140 281 3102
11/16"-11	0140 082 3104	0140 182 3104	0140 282 3102
3/4"-10	0140 083 3104	0140 183 3104	0140 283 3102
7/8"-9	0140 085 3104	0140 185 3104	0140 285 3102
1"-8	0140 086 3104	0140 186 3104	0140 286 3102
1 1/8"-7	0140 087 3104	0140 187 3104	0140 287 3102
1 1/4"-7	0140 088 3104	0140 188 3104	0140 288 3102
1 1/2"-6	0140 090 3104	0140 190 3104	0140 290 3102
BSF = British Standard Fine threads			
3/16"-32	0140 072 5104	0140 172 5104	0140 272 5102
7/32"-28	0140 073 5104	0140 173 5104	0140 273 5102
1/4"-26	0140 074 5104	0140 174 5104	0140 274 5102
9/32"-26	0140 075 5104	0140 175 5104	0140 275 5102
5/16"-22	0140 076 5104	0140 176 5104	0140 276 5102
3/8"-20	0140 077 5104	0140 177 5104	0140 277 5102
7/16"-18	0140 078 5104	0140 178 5104	0140 278 5102
1/2"-16	0140 079 5104	0140 179 5104	0140 279 5102
9/16"-16	0140 080 5104	0140 180 5104	0140 280 5102
5/8"-14	0140 081 5104	0140 181 5104	0140 281 5102
11/16"-14	0140 082 5104	0140 182 5104	0140 282 5102
3/4"-12	0140 083 5104	0140 183 5104	0140 283 5102
13/16"-12	0140 084 5104	0140 184 5104	0140 284 5102
7/8"-11	0140 085 5104	0140 185 5104	0140 285 5102
1"-10	0140 086 5104	0140 186 5104	0140 286 5102
1 1/8"-9	0140 087 5104	0140 187 5104	0140 287 5102
1 1/4"-9	0140 088 5104	0140 188 5104	0140 288 5102
1 3/8"-8	0140 089 5104	0140 189 5104	0140 289 5102
1 1/2"-8	0140 090 5104	0140 190 5104	0140 290 5102
BA = British Association Standard threads			
0 BA	0140 092 2104	0140 192 2104	0140 292 2102
1 BA	0140 093 2104	0140 193 2104	0140 293 2102
2 BA	0140 094 2104	0140 194 2104	0140 294 2102
3 BA	0140 095 2104	0140 195 2104	0140 295 2102
4 BA	0140 096 2104	0140 196 2104	0140 296 2102
5 BA	0140 097 2104	0140 197 2104	0140 297 2102
6 BA	0140 098 2104	0140 198 2104	0140 298 2102

Further sizes upon request.

*For tolerance class 3B the ninth digit of the item code changes from 1 to 2.

Types 0140.0 and 0140.2 can be utilised as machine taps. Shaft diameter tolerance h9.

They are especially suitable for brittle materials such as cast iron, brass and magnesium.

Machine taps for **HELICOIL® Classic** and **HELICOIL® Plus**



Type 0141.1

HELICOIL® machine tap,
straight-fluted, rake angle 10°, with spiral point
4-lead chamfer for through holes,
for blind holes with deeper drilled tap hole.

For materials with a strength of max. 850 N/mm^{2**}.



Type 0141.4

HELICOIL® machine tap,
spiral flutes 45° right-hand spiral, rake angle 15°,
2-lead chamfer for blind holes.

Also suitable for aluminium casting alloys with a very
low content of Si (≤ 2 %).

For aluminium wrought alloys with a strength of up
to 500 N/mm^{2**}.

To UNC 8-32/ UNF 8-36 2-groove.
Starting from UNC 10-24/ UNF 10-32 3-groove,
additionally also for soft steel to 450 N/mm² strength.



Type 0141.5

HELICOIL® machine tap,
spiral flutes 40° right-hand spiral, rake angle 10°,
2-lead chamfer for blind holes,
for blind holes with deeper drilled tap hole.

For steels with a strength from 500 N/mm^{2**} to
850 N/mm^{2**} maximum.

Also suitable for aluminium alloys with an Si content of
up to approximately 10%.

HELICOIL® special thread tapes for special applications
and materials see page 35.

** 1 N/mm² equals 1 Mpa

Nominal thread Ø d	for tolerance class 2B*		
	Type 0141.1 Item No	Type 0141.4 Item No	Type 0141.5 Item No
UNC/NC = American National Coarse threads			
2-56	0141 163 6104	0141 463 6152	0141 563 6102
4-40	0141 165 6104	0141 465 6152	0141 565 6102
5-40	0141 166 6104	0141 466 6152	0141 566 6102
6-32	0141 167 6104	0141 467 6152	0141 567 6102
8-32	0141 168 6104	0141 468 6152	0141 568 6102
10-24	0141 169 6104	0141 469 6152	0141 569 6102
12-24	0141 170 6104	0141 470 6152	0141 570 6102
1/4"-20	0141 174 6104	0141 474 6152	0141 574 6102
5/16"-18	0141 176 6104	0141 476 6152	0141 576 6102
3/8"-16	0141 177 6104	0141 477 6152	0141 577 6102
7/16"-14	0141 178 6104	0141 478 6152	0141 578 6102
1/2"-13	0141 179 6104	0141 479 6152	0141 579 6102
UNF = American National Fine threads			
4-48	0141 165 7104	0141 465 7152	0141 565 7102
6-40	0141 167 7104	–	0141 567 7102
8-36	0141 168 7104	0141 468 7152	0141 568 7102
10-32	0141 169 7104	0141 469 7152	0141 569 7102
1/4"-28	0141 174 7104	0141 474 7152	0141 574 7102
5/16"-24	0141 176 7104	0141 476 7152	0141 576 7102
3/8"-24	0141 177 7104	0141 477 7152	0141 577 7102
7/16"-20	0141 178 7104	0141 478 7152	0141 578 7102
1/2"-20	0141 179 7104	0141 479 7152	0141 579 7102
9/16"-18	–	0141 480 7152	0141 580 7102
5/8"-18	–	0141 481 7152	0141 581 7102
3/4"-16	–	0141 483 7152	0141 583 7102
BSW= British Standard Whitworth threads			
1/8"-40	0141 171 3104	0141 471 3152	0141 571 3102
3/16"-24	0141 172 3104	0141 472 3152	0141 572 3102
1/4"-20	0141 174 3104	0141 474 3152	0141 574 3102
5/16"-18	0141 176 3104	0141 476 3152	0141 576 3102
3/8"-16	0141 177 3104	0141 477 3152	0141 577 3102
7/16"-14	0141 178 3104	0141 478 3152	0141 578 3102
1/2"-12	0141 179 3104	0141 479 3152	0141 579 3102
9/16"-12	–	–	–
BSF = British Standard Fine threads			
9/16"-32	0141 172 5104	–	0141 572 5102
7/32"-28	0141 173 5104	–	0141 573 5102
1/4"-26	0141 174 5104	–	0141 574 5102
9/32"-26	0141 175 5104	–	0141 575 5102
5/16"-22	0141 176 5104	0141 476 5152	0141 576 5102
3/8"-20	0141 177 5104	0141 477 5152	0141 577 5102
7/16"-18	0141 178 5104	0141 478 5152	0141 578 5102
1/2"-16	0141 179 5104	–	0141 579 5102
9/16"-16	–	–	0141 580 5102
5/8"-14	–	–	0141 581 5102
11/16"-14	–	–	0141 582 5102
3/4"-12	–	–	0141 583 5102

Further sizes on request.

* For tolerance class 3B the ninth digit in the item code changes from 1 to 2.



Type 0141.0 / Type 0141.1

HELICOIL® machine tap,
straight-fluted, rake angle 10°, without spiral point
2-lead chamfer for blind holes.

For blind holes with deeper drilled tap hole.

For materials with a strength of max. 850 N/mm²**.



Type 0141.5

HELICOIL® machine tap,
spiral flutes 40° right-hand spiral, rake angle 10°,
2-lead chamfer for blind holes,
for blind holes with deeper drilled tap hole.

For steels with a strength from 500 N/mm²** to
850 N/mm²** maximum.

Also suitable for aluminium alloys with an Si content of
up to approximately 10%.

HELICOIL® special thread tapes for special applications
and materials see page 35.

** 1 N/mm² equals 1 Mpa

Nominal thread Ø	for tolerance class 2B*	for tolerance class 2B*
d	Types 0141.0 and 0141.1 Item No	Type 0141.5 Item No
BSP = British Standard Pipe threads · G = ISO 228/1 Pipe threads		
G 1/8"	0141 071 4102 ^①	–
G 1/4"	0141 074 4102 ^①	–
G 3/8"	0141 077 4102 ^①	–
G 1/2"	0141 079 4102 ^①	–
G 5/8"	0141 081 4102 ^①	–
G 3/4"	0141 083 4102 ^①	–
G 7/8"	0141 085 4102 ^①	–
G 1"	0141 086 4102 ^①	–
G 1 1/4"	0141 088 4102 ^①	–
G 1 1/2"	0141 090 4102 ^①	–
BA = British Association Standard threads		
0 BA	0141 192 2104	0141 592 2102
1 BA	0141 193 2104	0141 593 2102
2 BA	0141 194 2104	0141 594 2102
3 BA	0141 195 2104	0141 595 2102
4 BA	0141 196 2104	0141 596 2102
5 BA	0141 197 2104	0141 597 2102
6 BA	0141 198 2104	0141 598 2102

Further sizes on request.

For tolerance class 3B the ninth digit in the item code changes from 1 to 2.

① 2-lead chamfer

Threaded plug gauges for **HELICOIL® Plus** holding threads



Nominal thread Ø	for tolerance class 2B*	Nominal thread Ø	for tolerance class 2B*
d	Item No*	d	Item No*

UNC/NC = American National Coarse threads

2-56	0147 363 6500	1/2"-13	0147 379 6500
4-40	0147 365 6500	9/16"-12	0147 380 6500
5-40	0147 366 6500	5/8"-11	0147 381 6500
6-32	0147 367 6500	3/4"-10	0147 383 6500
8-32	0147 368 6500	7/8"-9	0147 385 6500
10-24	0147 369 6500	1"-8	0147 386 6500
12-24	0147 370 6500	1 1/8"-7	0147 387 6500
1/4"-20	0147 374 6500	1 1/4"-7	0147 388 6500
5/16"-18	0147 376 6500	1 3/8"-6	0147 389 6500
3/8"-16	0147 377 6500	1 1/2"-6	0147 390 6500
7/16"-14	0147 378 6500		

UNF/NF = American National Fine threads

4-48	0147 365 7500	5/8"-18	0147 381 7500
6-40	0147 367 7500	3/4"-16	0147 383 7500
8-36	0147 368 7500	7/8"-14	0147 385 7500
10-32	0147 369 7500	1"-14	0147 386 9500
1/4"-28	0147 374 7500	1"-12	0147 386 7500
5/16"-24	0147 376 7500	1 1/8"-12	0147 387 7500
3/8"-24	0147 377 7500	1 1/4"-12	0147 388 7500
7/16"-20	0147 378 7500	1 3/8"-12	0147 389 7500
1/2"-20	0147 379 7500	1 1/2"-12	0147 390 7500
9/16"-18	0147 380 7500		

Other dimensions on request.

* For tolerance class 3B, the ninth digit of the item code from 5 to 4.



Nominal thread Ø	for tolerance class 2B*	Nominal thread Ø	for tolerance class 2B*
d	Item No*	d	Item No*

BSW = British Standard Whitworth threads

1/8"-40	0147 371 3500	5/8"-11	0147 381 3500
3/16"-24	0147 372 3500	11/16"-11	0147 382 3500
1/4"-20	0147 374 3500	3/4"-10	0147 383 3500
5/16"-18	0147 376 3500	7/8"-9	0147 385 3500
3/8"-16	0147 377 3500	1"-8	0147 386 3500
7/16"-14	0147 378 3500	1 1/8"-7	0147 387 3500
1/2"-12	0147 379 3500	1 1/4"-7	0147 389 3500
9/16"-12	0147 380 3500	1 1/2"-6	0147 390 3500

BSF = British Standard Fine threads

3/16"-32	0147 372 5500	11/16"-14	0147 382 5500
7/32"-28	0147 373 5500	3/4"-12	0147 383 5500
1-4"-26	0147 374 5500	13/16"-12	0147 384 5500
9/32"-26	0147 375 5500	7/8"-11	0147 385 5500
5/16"-22	0147 376 5500	1"-10	0147 386 5500
3/8"-20	0147 377 5500	1 1/8"-9	0147 387 5500
7/16"-18	0147 378 5500	1 1/4"-9	0147 388 5500
1/2"-16	0147 379 5500	1 3/8"-8	0147 389 5500
9/16"-16	0147 380 5500	1 1/2"-8	0147 390 5500
5/8"-14	0147 381 5500		

BSP = British Standard Pipe threads G = ISO 228/1 Pipe threads

G 1/8"	0147 371 4500	G 3/4"	0147 383 4500
G 1/4"	0147 374 4500	G 7/8"	0147 385 4500
G 3/8"	0147 377 4500	G 1"	0147 386 4500
G 1/2"	0147 379 4500	G 1 1/4"	0147 388 4500
G 5/8"	0147 381 4500	G 1 1/2"	0147 390 4500

BA = British Association Standard threads

0 BA	0147 392 2500	4 BA	0147 396 2500
1 BA	0147 393 2500	5 BA	0147 397 2500
2 BA	0147 394 2500	6 BA	0147 398 2500
3 BA	0147 395 2500	-	-

Other dimensions on request.

* For tolerance class 3B, the ninth digit of the item code from 5 to 4.



System modules – the fastener

	Page
Technology	05
Designs	06
A close look at the advantages	08
Modular system	10
Materials	12
Design guidelines	13
Fields of application	14
Installation	16
Technical data and item numbers	18

System modules – the tool

All taps at a glance	34
Thread tolerances for imperial threads	36
Manual taps	38
Machine taps	40
Internal thread gauges	42

Installation

Installation mandrels	46
Installation tools	
Battery installation tools	48
Electrical installation tools	49
Pneumatic installation tools	50
Mechanical installation tools	52
Accessories	56
Automatic installation	57
Manual installation tools	58
Tang break-off and extraction tools	60



HELICOIL® Plus installation mandrel

HELICOIL® Plus installation mandrels can be used with the following tools:

- Electrical installation tools type E-S 206 and E-S 410
- Battery installation tools type B-S 206 and B-S 824
- Pneumatic installation tools P-S 412 and P-S 1216

Your benefits

- Quick tool change
- Reduced tool costs
- Pick-and-place processing possible

Installation mandrel spindle with depth stop

Only for installation of HELICOIL® Plus Free Running and Screwlock.
With 1/4" external hexagon DIN 3126 – E 6.3/DIN ISO 1173.

For installation tools types B-S 206, E-S 206, E-S 410 and P-S 412

Nominal thread \varnothing	Mandrel Free Running Item No	Mandrel Screwlock Item No	L_1	L_2 max	L	D_1	D_2	Design
------------------------------	---------------------------------	------------------------------	-------	--------------	---	-------	-------	--------

UNC/NC = American National Coarse threads

2-56	4160 236 3620	4160 236 3620	17	17	113	8	8	1
4-40	4160 236 5620	4160 236 5620	22	22	118	8	8	1
5-40	4160 236 6620	4160 236 6620	24	24	117	8	8	1
6-32	4160 236 7620	4160 236 7620	26	26	119	8	8	1
8-32	4160 236 8620	4160 236 8622	35	19	100	8	8	1
10-24	4160 236 9620	4160 236 9620	49	32	105	9	8	1
12-24	4160 237 0620	4160 237 0620	49	32	105	10	8	1

UNF/NF = American National Fine threads

4-48	4160 236 5720	4160 236 5722	22	22	118	6	8	1
6-40	4160 236 7720	4160 236 7722	44	30	100	8	8	1
8-36	4160 236 8720	4160 236 8722	44	30	100	8	8	1
10-32	4160 236 9720	4160 236 9722	49	34	105	10	8	1

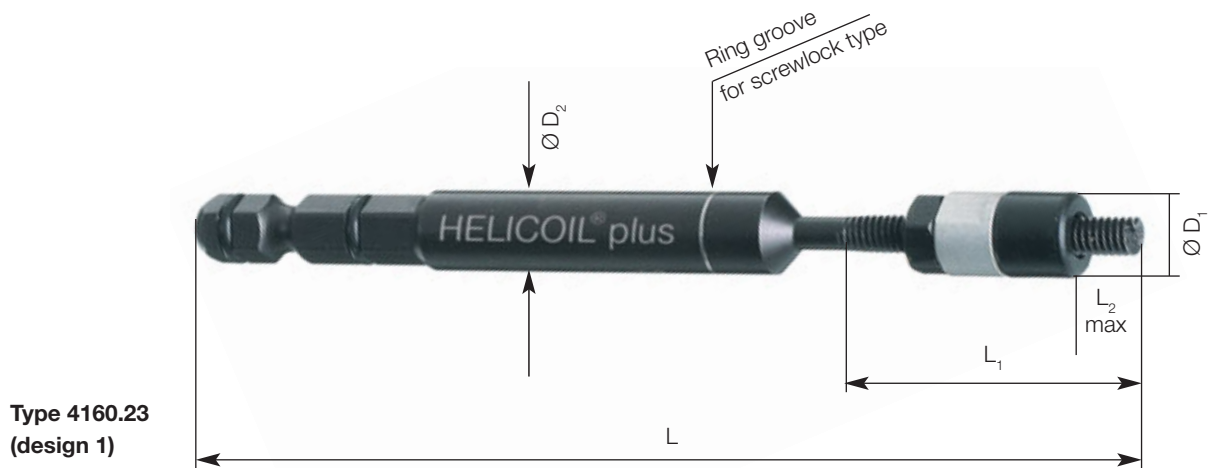

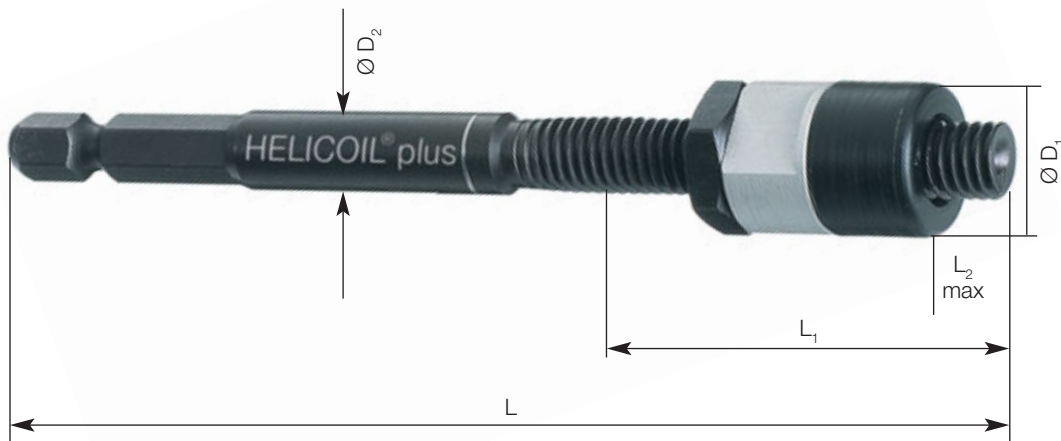

**Type 4160.25
(design 2)**

For installation tools types B-S 824, E-S 410, P-S 412 and P-S 1216

Nominal thread Ø	Mandrel Free Running Item No	Mandrel Screwlock Item No	L ₁	L ₂ max	L	D ₁	D ₂	Design
1/4"-20	4160 257 4620	4160 257 4620	49	32	105	12	8	2
5/16"-18	4160 257 6620	4160 257 6620	49	32	105	16	8	2
3/8"-16	4160 257 7620	4160 257 7620	59	35	115	16	8	2
7/16"-14	4160 257 8620	4160 257 8620	64	42	120	20	8	2
1/2"-13	4160 257 9620	4160 257 9620	74	48	130	21	8	2

Adapted tools for inserts of Inconel X 750, Nimonic 90 and aluminium on request.



These installation mandrels can also be used as manual installation mandrels.

HELICOIL® Plus Screwlock installation mandrels are marked with a ring groove on the guide shaft. HELICOIL® Free Running installation mandrels have a smooth guide shaft.

Installation tools for **HELICOIL® Plus**

Basically, there are three types of installation tools. Installation tools are chosen based on the volume of HELICOIL® Plus thread inserts to process, the location of the tapped holes in the workpiece and the thread size.

Hence, there are:

- Manual installation tools
- Electrical installation tools
- Electrical installation tools with battery power
- Pneumatic installation tools

Battery installation tools



Battery power pack installation tool type B-S 206

For processing HELICOIL® Plus UNC 2-56 to UNC 1/4"-20 and UNF 4-48 to UNF 1/4"-28 with HELICOIL® Plus installation mandrel

Delivery scope:

- Battery gun-straight installation tool (articulated)
- 2 pieces battery pack 3.6 V; 1.5 Ah
- Quick charger
- Case

Technical data:

Idle speed:	Two-speed 200 rpm and 600 rpm, reversible
Torque:	Adjustable in 21 steps 0.3–2.9 Nm/4.4 Nm max.
Tool holder:	1/4" hexagon socket
Weight incl. battery:	0.5 kg
Battery:	3.6 V/1.5 Ah/charging time 30 min
Item No:	4160 430 0000

Spare parts and accessories:

Spare battery:	Item No 4160 430 0200
Quick charger:	Item No 4160 430 0300



Battery power pack installation tool type B-S 824

For processing HELICOIL® Plus UNC 5/16"-18 to UNC 1/2"-13 and UNF 5/16"-24 to UNF 1/2"-20 with HELICOIL® Plus installation mandrel

Delivery scope:

- Battery gun screwdriver
- 2 pieces battery pack 15.6 V; 3 Ah
- Quick charger
- Case

Technical data:

Idle speed:	Speed 1/stepless 65– 450 rpm, reversible Speed 2/stepless 200– 1450 rpm, reversible
Torque:	19-step adjustable 1–6.9 Nm/31.9 Nm max.
Tool holder:	Three-jaw chuck 1.0–13 mm
Weight incl. battery:	2.0 kg
Battery:	15.6 V/3 Ah/charging time 45 min
Item No:	4160 350 0000

Spare parts and accessories:

Spare battery:	Item No 4160 350 0200
Quick charger:	Item No 4160 350 0300

Electrical installation tools



Type E-S 206

For quick processing of HELICOIL® Plus thread inserts UNC 2-56 to UNC 1/4"-20 and UNF 4-48 to UNF 1/4"-28 with HELICOIL® Plus installation mandrel

Delivery scope:

- Straight screwdriver with 1/4" hexagon
- Power supply for two screwdrivers
- Case

Technical data:

Idle speed:	720 rpm
Output voltage:	35 V DC
Torque:	M = 0.45 – 0.95 Nm
	Steplessly adjustable shut-off clutch
Tool holder:	1/4" hexagon socket with radial bearing
Weight:	0.31 kg
Item No:	4160 220 0000

The installation mandrels for all available sizes are provided on page 46 and 47.



Type E-S 410

For quick processing of HELICOIL® Plus thread inserts UNC 8-32 to UNC 3/8"-16 and UNF 8-36 to UNF 3/8"-24 with HELICOIL® Plus installation mandrel

Delivery scope:

- Straight screwdriver with quick-change chuck 1/4" hexagon socket
- Speed control with ramp control on control device EDU 2AE
- Case

Technical data:

Idle speed:	1200 rpm (steplessly adjustable)
	Automatic change-over of the direction of rotation when reaching the screw-in depth
Torque:	0.9 to 3 Nm
	Torque steplessly adjustable on the control device
Tool holder:	Quick-change chuck 1/4" hexagon socket with radial bearing for installation mandrel
Weight:	0.57 kg
Item No:	4160 540 0000

The installation mandrels for all available sizes are provided on page 46 and 47.



Type E-PSG 256 with leader cartridge

For quick processing of HELICOIL® Plus thread inserts UNC 4-40 to UNF 1/4"-28 with HELICOIL® Plus exchange unit

Delivery scope: See type E-S 410

Technical data:

Idle speed:	1200 rpm (steplessly adjustable)
	Automatic change-over of the direction of rotation when reaching the screw-in depth
Torque:	0.9 to 3 Nm
	Torque steplessly adjustable on the control device
Tool holder:	Connection for leader cartridges of P-PSG 256
Weight:	0.75 kg
Item No:	0160 470 0000

The exchange units for all available sizes are provided on pages 46 and 47.

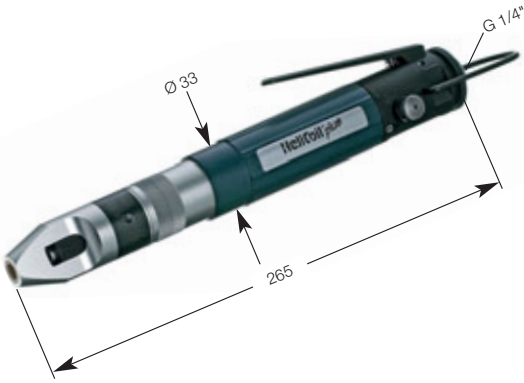

Pneumatic installation tool type P-S 412

For quick processing of HELICOIL® Plus UNC 8-32 to UNC 1/2"-13 and UNF 8-36 to UNF 1/2"-20 with HELICOIL® Plus installation mandrel

Technical data:

Idle speed:	1500 rpm at p = 6.3 bar Adjustable through air pressure
Air consumption:	5.5 l/s at p = 6.3 bar
Torque:	M = 1.2–4.5 Nm Steplessly adjustable shut-off clutch
Tool holder:	Quick-action chuck 1/4" hexagon socket DIN 3120-E 6,3 with radial bearing for installation mandrel
Weight:	0.8 kg
Item No:	4160 270 0010

HELICOIL® Plus installation mandrels depending on the size with depth stop must be ordered separately, see page 46 and 47.

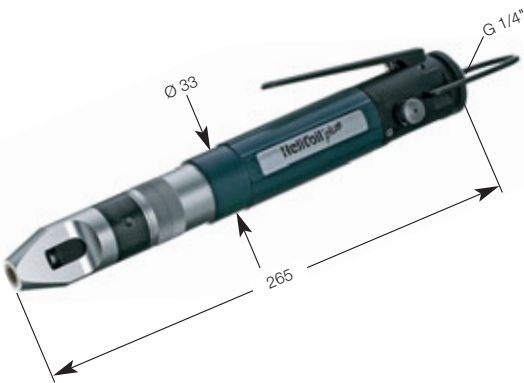

Pneumatic installation tool type P-S 1216

For quick processing of HELICOIL® Plus UNC 7/16" and UNC 1/2"-13 and UNF 7/16"-20 and UNF 1/2"-20 with HELICOIL® Plus installation mandrel

Technical data:

Idle speed:	950 rpm at p = 6.3 bar Adjustable through air pressure
Air consumption:	5.5 l/s at p = 6.3 bar
Torque:	M = 1.2–5.5 Nm Steplessly adjustable shut-off clutch
Tool holder:	Quick-action chuck 1/4" hexagon socket DIN 3120-E 6,3 with radial bearing for installation mandrel
Weight:	0.8 kg
Item No:	4160 180 0010

HELICOIL® Plus installation mandrels depending on the size with depth stop must be ordered separately, see page 46 and 47.

**Spare handle for P-S 1216**

Handle for safe compensation of installation torque for sizes \geq UNC 7/16"-14 and UNF 7/16"-20

Item No: **4160 180 0006**

**Suspension bracket for P-S 412 and P-S 1216**

For horizontal suspension of tools on counterbalance systems

For details, see page 56

Item No: **4160 180 0007**

For **HELICOIL®** Classic and **HELICOIL®** Plus Free Running and Screwlock

Pitch-controlled **HELICOIL®** Classic and **HELICOIL®** Plus installation tool for **bulk material processing**.

The installation tool is equipped with a reversible compressed-air motor and a size-dependent exchange unit. The **HELICOIL®** installation depth is adjusted with compensation washers. We recommend this tool for medium and large scale production.

Complete tool

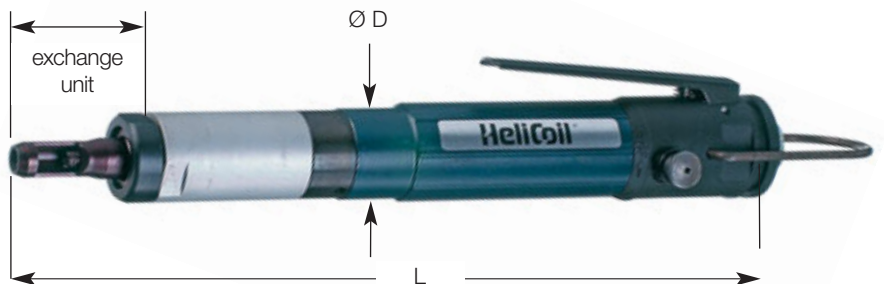

Type**	Nominal thread Ø d	Complete tool Item No	Dimensions		Weight kg	Connection bar	*Air consumption l/Min.
			Ø D	L			
UNC/NC = American National Coarse threads							
P-PSG 256	2-56	0160 376 3600	28	240	0.6	2.5-4.0	204
	4-40	0160 376 5600	28	240	0.6	2.5-4.0	204
	5-40	0160 376 6600	28	240	0.6	2.5-4.0	204
	6-32	0160 376 7600	28	240	0.6	2.5-4.0	204
	8-32	0160 376 8600	28	240	0.6	2.5-4.0	204
	10-24	0160 376 9600	28	240	0.6	2.5-4.0	204
	12-24	0160 377 0600	28	240	0.6	2.5-4.0	204
	1/4"-20	0160 377 4600	28	240	0.6	2.5-4.0	204
P-PSG 714	5/16"-18	0160 287 6600	42	360	1.4	4.0-5.0	282
	3/8"-16	0160 287 7600	42	360	1.4	4.0-5.0	282
	7/16"-14	0160 287 8600	42	360	1.4	4.0-5.0	282
	1/2"-13	0160 287 9600	42	360	1.4	4.0-5.0	282
UNF/NF = American National Fine threads							
P-PSG 256	4-48	0160 376 5700	28	240	0.6	2.5-4.0	204
	6-40	0160 376 7700	28	240	0.6	2.5-4.0	204
	8-36	0160 376 8700	28	240	0.6	2.5-4.0	204
	10-32	0160 376 9700	28	240	0.6	2.5-4.0	204
	1/4"-28	0160 377 4700	28	240	0.6	2.5-4.0	204
P-PSG 714	5/16"-24	0160 287 6700	42	360	1.4	4.0-5.0	282
	3/8"-24	0160 287 7700	42	360	1.4	4.0-5.0	282
	7/16"-20	0160 287 8700	42	360	1.4	4.0-5.0	282
	1/2"-20	0160 287 9700	42	360	1.4	4.0-5.0	282

Important order information:

When you order tools, specify type, size and length of **HELICOIL®** Plus thread inserts to process. Tools for installation of **HELICOIL®** Plus thread inserts with lengths $\geq 2.5 d$ on request. As required by German accident prevention regulations (UVV), types P-PSG 714 and P-PSG 1626 are equipped with a sliding sleeve as finger guard.

This finger guard must not be removed.

Installation tools are equipped with industrial Bosch motors.

*Air consumption at 6.3 bar.

**Exchange units can be interchanged within the individual series.

Adapted tools for inserts of Inconel X 750, Nimonic 90 and aluminium on request.

Subassemblies

Exchange unit



Basic tool



Motor



Type**	Nominal thread Ø d	Exchange unit Item No	Basic tool Item No	Motor Item No
UNC/NC = American National Coarse threads				
P-PSG 256	2-56	0160 276 3650	0160 370 0040	0160 370 0010
	4-40	0160 176 5650		
	5-40	0160 176 6650		
	6-32	0160 176 7650		
	8-32	0160 176 8650		
	10-24	0160 176 9650		
	12-24	0160 177 0650		
P-PSG 714	1/4"-20	0160 177 4650	0160 180 0040	0160 180 0011
	5/16"-18	0160 287 6650		
	3/8"-16	0160 287 7650		
	7/16"-14	0160 287 8650		
	1/2"-13	0160 287 9650		
UNF/NF = American National Fine threads				
P-PSG 256	4-48	0160 176 5750	0160 370 0040	0160 370 0010
	6-40	0160 176 7750		
	8-36	0160 176 8750		
	10-32	0160 176 9750		
	1/4"-28	0160 177 4750		
P-PSG 714	5/16"-24	0160 287 6750	0160 180 0040	0160 180 0011
	3/8"-24	0160 287 7750		
	7/16"-20	0160 287 8750		
	1/2"-20	0160 287 9750		

Wear and spare parts

Prewinder



Installation mandrel



Clutch for installation mandrel



Range of compensation washers



Type**	Nominal thread Ø d	Prewinder Item no.	Installation mandrel Item no.	Clutch for installation mandrel Item no.	Range of compensation washers Item no.
UNC/NC = American National Coarse threads					
P-PSG 256	2-56	0160 276 3632	0160 276 3620	0160 170 0006	0160 170 0060
	4-40	0160 176 5632	0160 276 5620		
	5-40	0160 176 6632	0160 176 6620		
	6-32	0160 176 7632	0160 276 7620		
	8-32	0160 176 8632	0160 276 8620		
	10-24	0160 176 9632	0160 276 9620		
	12-24	0160 177 0632	0160 177 0620		
	1/4"-20	0160 277 4632	0160 277 4620		
P-PSG 714	5/16"-18	0160 287 6632	0160 287 6620	0160 180 0006	0160 280 0060
	3/8"-16	0160 287 7632	0160 287 7620		
	7/16"-14	0160 287 8632	0160 187 8620		
	1/2"-13	0160 287 9632	0160 287 9620		
UNF/NF = American National Fine threads					
P-PSG 256	4-48	0160 176 5732	0160 176 5720	0160 170 0006	0160 170 0060
	6-40	0160 176 7732	0160 176 7720		
	8-36	0160 176 8732	0160 176 8720		
	10-32	0160 276 9732	0160 276 9720		
	1/4"-28	0160 177 4732	0160 277 4720		
P-PSG 714	5/16"-24	0160 287 6732	0160 287 6720	0160 180 0006	0160 280 0060
	3/8"-24	0160 287 7732	0160 287 7720		
	7/16"-20	0160 287 8732	0160 187 8720		
	1/2"-20	0160 287 9732	0160 287 9720		

Exemplary illustrations.

For HELICOIL® Classic STRIPFEED® and HELICOIL® Plus STRIPFEED®

Pitch-controlled HELICOIL® Classic and HELICOIL® Plus installation tool for processing **magazined thread inserts**.

The installation tool is equipped with a reversible compressed-air motor and a size-dependent exchange unit.

The HELICOIL® installation depth is adjusted with compensation washers.

We recommend this tool for medium and large scale production.

Complete tool

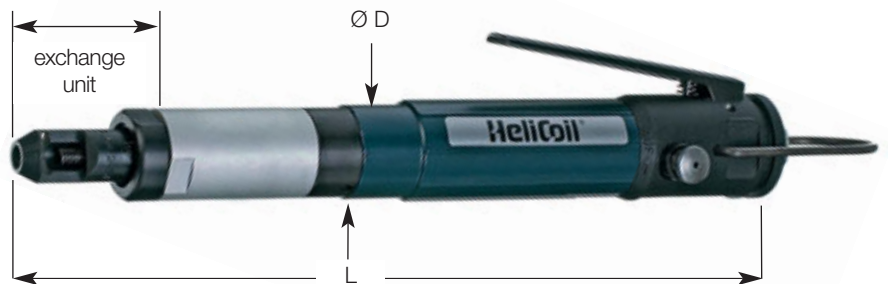

Type**	Nominal thread Ø	Complete tool	Dimensions		Weight	Connec-tion	*Air con-sumption
	d	Item No	Ø D	L	kg	bar	l/Min.
UNC/NC = American National Coarse threads							
P-PSG 256 SF	2-56	0160 376 3603	28	240	0.6	2.5-4.0	204
	4-40	0160 376 5603	28	240	0.6	2.5-4.0	204
	5-40	0160 376 6603	28	240	0.6	2.5-4.0	204
	6-32	0160 376 7603	28	240	0.6	2.5-4.0	204
	8-32	0160 376 8603	28	240	0.6	2.5-4.0	204
	10-24	0160 376 9603	28	240	0.6	2.5-4.0	204
	12-24	0160 377 0603	28	240	0.6	2.5-4.0	204
	1/4"-20	0160 377 4603	28	240	0.6	2.5-4.0	204
P-PSG 714 SF	5/16"-18	0160 287 6603	42	360	1.4	4.0-5.0	282
	3/8"-16	0160 287 7603	42	360	1.4	4.0-5.0	282
	7/16"-14	0160 287 8603	42	360	1.4	4.0-5.0	282
	1/2"-13	0160 287 9603	42	360	1.4	4.0-5.0	282
UNF/NF = American National Fine threads							
P-PSG 256 SF	4-48	0160 376 5703	28	240	0.6	2.5-4.0	204
	6-40	0160 376 7703	28	240	0.6	2.5-4.0	204
	8-36	0160 376 8703	28	240	0.6	2.5-4.0	204
	10-32	0160 376 9703	28	240	0.6	2.5-4.0	204
	1/4"-28	0160 377 4703	28	240	0.6	2.5-4.0	204
P-PSG 714 SF	5/16"-24	0160 287 6703	42	360	1.4	4.0-5.0	282
	3/8"-24	0160 287 7703	42	360	1.4	4.0-5.0	282
	7/16"-20	0160 287 8703	42	360	1.4	4.0-5.0	282
	1/2"-20	0160 287 9703	42	360	1.4	4.0-5.0	282

Important order information:

When you order tools, specify type, size and length of HELICOIL® Plus thread inserts to process.

Tools for installation of HELICOIL® Plus thread inserts with lengths ≥ 2.5 d on request.

Installation tools are equipped with industrial Bosch motors.

*Air consumption at 6.3 bar.

Other length on request.

**Exchange units can be interchanged within the individual series.

Adapted tools for inserts of Inconel X 750, Nimonic 90 and aluminium on request.

Subassemblies

Exchange unit



Basic tool



Motor



Type**	Nominal thread Ø	Exchange unit ≤ 2 d	Basic tool	Motor
	d	Item No	Item No	Item No
UNC/NC = American National Coarse threads				
P-PSG 256 SF	2-56	0160 276 3653	0160 370 0040	0160 370 0010
	4-40	0160 176 5653		
	5-40	0160 176 6653		
	6-32	0160 176 7653		
	8-32	0160 176 8653		
	10-24	0160 176 9653		
	12-24	0160 177 0653		
P-PSG 714 SF	1/4"-20	0160 177 4653	0160 180 0040	0160 180 0010
	5/16"-18	0160 287 6653		
	3/8"-16	0160 287 7653		
	7/16"-14	0160 187 8653		
	1/2"-13	0160 287 9653		
UNF/NF = American National Fine threads				
P-PSG 256 SF	4-48	0160 176 5753	0160 370 0040	0160 370 0010
	6-40	0160 176 7753		
	8-36	0160 176 8753		
	10-32	0160 176 9753		
	1/4"-28	0160 177 4753		
	5/16"-24	0160 287 6753		
P-PSG 714 SF	3/8"-24	0160 287 7753	0160 180 0040	0160 180 0011

Wear and spare parts

Prewinder



Installation mandrel



Clutch for installation mandrel



Range of compensation washers



Type**	Nominal thread Ø	Prewinder	Installation mandrel	Clutch for installation mandrel	Range of compensation washers	
	d	Item No	Item No	Item No	Item No	
UNC/NC = American National Coarse threads						
P-PSG 256	2-56	0160 276 3632	0160 276 3620	0160 170 0006	0160 170 0060	
	4-40	0160 176 5632	0160 276 5620			
	5-40	0160 176 6632	0160 176 6620			
	6-32	0160 176 7632	0160 276 7620			
	8-32	0160 176 8632	0160 276 8620			
	10-24	0160 176 9632	0160 276 9620			
	12-24	0160 177 0632	0160 177 0620			
	1/4"-20	0160 277 4632	0160 277 4620			0160 170 0066
P-PSG 714	5/16"-18	0160 287 6632	0160 287 6620	0160 180 0006	0160 280 0060	
	3/8"-16	0160 287 7632	0160 287 7620			
	7/16"-14	0160 287 8632	0160 187 8620			
	1/2"-13	0160 287 9632	0160 287 9620			
UNF/NF = American National Fine threads						
P-PSG 256	4-48	0160 176 5732	0160 176 5720	0160 170 0006	0160 170 0060	
	6-40	0160 176 7732	0160 176 7720			
	8-36	0160 176 8732	0160 176 8720			
	10-32	0160 276 9732	0160 276 9720			
	1/4"-28	0160 177 4732	0160 277 4720			0160 170 0066
	5/16"-24	0160 287 6732	0160 287 6720			0160 180 0006
P-PSG 714	3/8"-24	0160 287 7732	0160 287 7720			
	7/16"-20	0160 287 8732	0160 187 8720			
	1/2"-20	0160 287 9732	0160 287 9720			

Exemplary illustrations.

Parallel system S for HELICOIL® Classic and HELICOIL® Plus installation tools



Type	Product characteristics		Item No
S 600	Work radius	130 mm–450 mm	0182 080 0003 (see delivery scope)
	Work height	50 mm–450 mm	
	Weight without tool	8 kg	
	Torque absorption	15 Nm max.	

Advantages

- Rationalisation
- Quick and positioning especially for small dimensions
- Easy handling, no operator fatigue
- No return rotation forces
- Absorption of screwdriver weight
- Can be used with electrical and pneumatic HELICOIL® installation tools
- Quick tool change
- 360° rotatable
- Smooth and precise roller guides
- Optimum workstation layout

Delivery scope

- 3-axis guiding system
- Tool holder
- 1 counterbalance 1–3 kg
- Base plate made of extruded aluminium profile with grooves, dimensions w x h x l: 240 x 40 x 500 mm

Accessories

Type	Size	Item No
Service unit	at 6 bar nominal flow G01" = 700l/min	0182 080 1001
Stationary roller holder for HELICOIL® Plus STRIPFEED®		0182 080 0004
Hose	ID 6	0196 000 1130
Hose clip	8–12 mm	0196 000 1150
Hose tail	G 1/8" -6	0196 000 1151
Hose tail	G 1/4" -6	0196 000 1152
Exhaust air hose	Ø 15 mm	0196 000 1131



Drill chuck with external hexagon

DIN 3126 – E 6.3 for type B-S 206
Item No 4160 000 0100

HELICOIL® Plus automatic installation

The economical installation of HELICOIL® Plus thread inserts is just as important as the high quality standard.

That is why we offer modules for integration into automatic processes as well as complete systems.

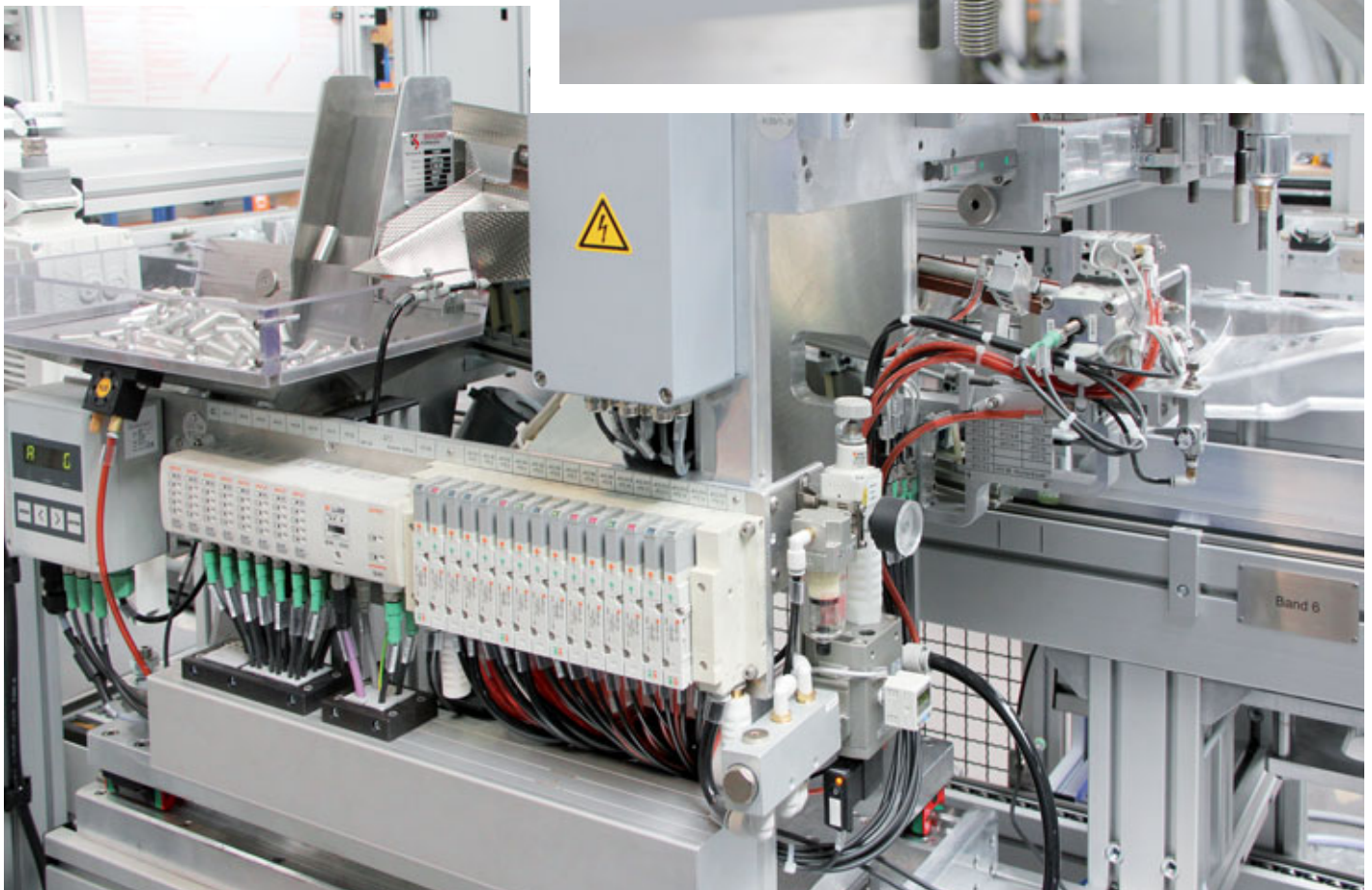

Manual installation tools for **HELICOIL®**

Manual installation tool with prewinder for HELICOIL® Classic and HELICOIL® Plus. Only required for HELICOIL® Plus for fine screw threads and special applications.



Type **H-PSG**:
Threadet mandrel, pitch-controlled,
with depth stop
Item No 0150 **01**. ...*



Type **H-PMG**:
Plain mandrel, pitch-controlled,
with depth stop
Item No 0150 **02**. ...*



Type **H-PM**:
Plain mandrel, without pitch control,
with depth stop
Item No 0150 **04**. ...*



**Fly-over tool for
HELICOIL® Classic and HELICOIL® Plus**
Type **H-M**
with depth stop
Item No 0150 **07**. ...*

Nominal thread Ø		Installation tool with prewinder	Fly-over tool Type H-M
d	Type	Item No	Item No
UNC/NC = American National Coarse threads			
2-56	H-PSG UNC 2-56	on request	-
4-40	H-PSG UNC 4-40	0150 016 5600	-
5-40	H-PSG UNC 5-40	0150 016 6600	-
6-32	H-PSG UNC 6-32	0150 016 7600	-
8-32	H-PSG UNC 8-32	0150 016 8600	-
10-24	H-PSG UNC 10-24	0150 016 9600	-
12-24	H-PM UNC 12-24	0150 047 0600	-
1/4"-20	H-PM UNC 1/4"-20	0150 047 4600	-
5/16"-18	H-PM UNC 5/16"-18	0150 047 6600	-
3/8"-16	H-PM UNC 3/8"-16	0150 047 7600	-
7/16"-14	H-PM UNC 7/16"-14	0150 047 8600	-
1/2"-13	H-PM UNC 1/2"-13	0150 047 9600	-
9/16"-12	H-PM UNC 9/16"-12	0150 048 0600	-
5/8"-11	H-M UNC 5/8"-11	-	0150 078 1000
3/4"-10	H-M UNC 3/4"-10	-	0150 078 3000
7/8"-9	H-M UNC 7/8"-9	-	0150 078 5000
1"-8	H-M UNC 1"-8	-	0150 078 6000
1 1/8"-7	H-M UNC 1 1/8"-7	-	0150 078 7000
1 1/4"-7	H-M UNC 1 1/4"-7	-	0150 078 8000
1 3/8"-6	H-M UNC 1 3/8"-6	-	0150 078 9000
1 1/2"-6	H-M UNC 1 1/2"-6	-	0150 079 0000
UNF/NF = American National Fine threads			
4-48	H-PSG UNF 4-48	0150 016 5700	-
6-40	H-PSG UNF 6-40	0150 016 7700	-
8-36	H-PSG UNF 8-36	0150 016 8700	-
10-32	H-PSG UNF 10-32	0150 016 9700	-
1/4"-28	H-PSG UNF 1/4"-28	0150 017 4700	-
5/16"-24	H-PSG UNF 5/16"-24	0150 017 6700	-
3/8"-24	H-PSG UNF 3/8"-24	0150 017 7700	-
7/16"-20	H-PSG UNF 7/16"-20	0150 017 8700	-
1/2"-20	H-PSG UNF 1/2"-20	0150 017 9700	-
9/16"-18	H-PMG UNF 9/16"-18	0150 028 0700	-
5/8"-18	H-PMG UNF 5/8"-18	0150 028 1700	-
3/4"-16	H-PMG UNF 3/4"-16	0150 028 3700	-
7/8"-14	H-PMG UNF 7/8"-14	0150 028 5700	-
1"-14	H-PMG UNF 1"-14	0150 028 6900	-
1"-12	H-PMG UNF 1"-12	0150 028 6700	-
1 1/8"-12	H-PMG UNF 1 1/8"-12	0150 028 7700	-
1 1/4"-12	H-PMG UNF 1 1/4"-12	0150 028 8700	-
1 3/8"-12	H-PMG UNF 1 3/8"-12	0150 028 9700	-
1 1/2"-12	H-PMG UNF 1 1/2"-12	0150 029 0700	-

* Adapted tools for thread inserts of NiCr 15 Fe 7 Ti Al, NiCr 20 Co 18 Ti, AlZn Mg Cu 1.5 on request.

Manual installation tool with prewinder for HELICOIL® Classic and HELICOIL® Plus. Only required for HELICOIL® Plus for fine screw threads and special applications.



Type **H-PSG**:
Threadet mandrel, pitch-controlled,
with depth stop
Item No 0150 **01**. ...*



Type **H-PMG**:
Plain mandrel, pitch-controlled,
with depth stop
Item No 0150 **02**. ...*



Type **H-PM**:
Plain mandrel, without pitch control,
with depth stop
Item No 0150 **04**. ...*



**Fly-over tool for
HELICOIL® Classic and HELICOIL® Plus**
Type **H-M**
with depth stop
Item No 0150 **07**. ...*

Nominal thread Ø	Type	Installation tool with prewinder	Fly-over tool Type H-M
d		Item No	Item No
BSW= British Standard Whitworth threads			
1/8"-40	H-PSG BSW 1/8"-40	0150 017 1300	-
3/16"-24	H-PSG BSW 3/16"-24	0150 017 2300	-
1/4"-20	H-PM BSW 1/4"-20	0150 047 4300	-
5/16"-18	H-PM BSW 5/16"-18	0150 047 6300	-
3/8"-16	H-PM BSW 3/8"-16	0150 047 7300	-
7/16"-14	H-PM BSW 7/16"-14	0150 047 8300	-
1/2"-12	H-PM BSW 1/2"-12	0150 047 9300	-
9/16"-12	H-PM BSW 9/16"-12	0150 048 0300	-
5/8"-11	H-M BSW 5/8"-11	-	0150 078 1000
11/16"-11	H-M BSW 11/16"-11	-	0150 078 2000
3/4"-10	H-M BSW 3/4"-10	-	0150 078 3000
7/8"-9	H-M BSW 7/8"-9	-	0150 078 5000
1"-8	H-M BSW 1"-8	-	0150 078 6000
1 1/8"-7	H-M BSW 1 1/8"-7	-	0150 078 7000
1 1/4"-7	H-M BSW 1 1/4"-7	-	0150 078 8000
1 1/2"-6	H-M BSW 1 1/2"-6	-	0150 079 0000
BSF = British Standard Fine threads			
3/16"-32	H-PSG BSF 3/16"-32	0150 017 2500	-
7/32"-28	H-PSG BSF 7/32"-28	0150 017 3500	-
1/4"-26	H-PM BSF 1/4"-26	0150 047 4500	-
9/32"-26	H-PM BSF 9/32"-26	0150 047 5500	-
5/16"-22	H-PM BSF 5/16"-22	0150 047 6500	-
3/8"-20	H-PM BSF 3/8"-20	0150 047 7500	-
7/16"-18	H-PM BSF 7/16"-18	0150 047 8500	-
1/2"-16	H-PM BSF 1/2"-16	0150 047 9500	-
9/16"-16	H-PM BSF 9/16"-16	0150 048 0500	-
5/8"-14	H-PM BSF 5/8"-14	0150 048 1500	-
11/16"-14	H-PM BSF 11/16"-14	0150 048 2500	-
3/4"-12	H-PM BSF 3/4"-12	0150 048 3500	-
13/16"-12	H-PM BSF 13/16"-12	0150 048 4500	-
7/8"-11	H-PM BSF 7/8"-11	0150 048 5500	-
1"-10	H-PM BSF 1"-10	0150 048 6500	-
1 1/8"-9	H-PM BSF 1 1/8"-9	0150 048 7500	-
1 1/4"-9	H-PM BSF 1 1/4"-9	0150 048 8500	-
1 3/8"-8	H-PM BSF 1 3/8"-8	0150 048 9500	-
1 1/2"-8	H-PM BSF 1 1/2"-8	0150 049 0500	-
BSP = British Standard Pipe thread · G = ISO 228/1 Pipe threads			
G 1/8"	H-PSG G 1/8"	0150 017 1400	-
G 1/4"	H-PMG G 1/4"	0150 027 4400	-
G 3/8"	H-PMG G 3/8"	0150 027 7400	-
G 1/2"	H-PMG G 1/2"	0150 027 9400	-
G 5/8"	H-PMG G 5/8"	0150 028 1400	-
G 3/4"	H-PMG G 3/4"	0150 028 3400	-
G 7/8"	H-PMG G 7/8"	0150 028 5400	-
G 1"	H-PMG G 1"	0150 028 6400	-
G 1 1/4"	H-PMG G 1 1/4"	0150 028 8400	-
G 1 1/2"	H-PMG G 1 1/2"	0150 029 0400	-
BA = British Association Standard threads			
0 BA	H-PM 0 BA	0150 049 2200	-
1 BA	H-PSG 1 BA	0150 019 3200	-
2 BA	H-PSG 2 BA	0150 019 4200	-
3 BA	H-PSG 3 BA	0150 019 5200	-
4 BA	H-PSG 4 BA	0150 019 6200	-
5 BA	H-PSG 5 BA	0150 019 7200	-
6 BA	H-PSG 6 BA	0150 019 8200	-

* Adapted tools for thread inserts of NiCr 15 Fe 7 Ti Al, NiCr 20 Co 18 Ti, AlZn Mg Cu 1,5 on request.

Tang break-off tools for **HELICOIL® Classic** and **HELICOIL® Plus**



Tang break-off mandrel



Mechanical tang break-off tool with spring tension **type TB-M**



Pneumatic tang break-off tool with thrust trigger **type TB-P**

Nominal thread Ø	Tang break-off mandrel	Type TB-M	Type TB-P pneumatic system*
d	Item No	Item No	Item No
UNC/NC = American National Coarse threads			
2-56	0158 040 0000	0158 602 0000	–
4-40	0158 040 1000	0158 603 0000	0168 040 3000
5-40	0158 040 1000	0158 603 0000	0168 040 3000
6-32	0158 040 2000	0158 603 0000	0168 040 4000
8-32	0158 040 2000	0158 604 0000	0168 040 4000
10-24	0158 040 3000	0158 604 0000	0168 040 5000
12-24	0158 040 3000	0158 605 0000	0168 040 5000
1/4"-20	0158 040 3000	0158 606 0000	0168 040 6000
5/16"-18	0158 040 5000	0158 607 0000	0168 040 8000
3/8"-16	0158 040 5000	0158 609 0000	0168 041 0000
7/16"-14	0158 040 6000	0158 610 0000	0168 041 0000
1/2"-13	0158 040 6000	0158 610 0000	0168 041 2000
9/16"-12	–	0158 612 0000	–
5/8"-11	–	0158 614 0000	–
UNF/NF = American National Fine threads			
4-48	0158 040 1000	0158 603 0000	0168 040 3000
6-40	0158 040 2000	0158 603 0000	0168 040 4000
8-36	0158 040 2000	0158 604 0000	0168 040 4000
10-32	0158 040 3000	0158 604 0000	0168 040 5000
1/4"-28	0158 040 3000	0158 606 0000	0168 040 6000
5/16"-24	0158 040 4000	0158 608 0000	0168 040 8000
3/8"-24	0158 040 4000	0158 609 0000	0168 041 0000
7/16"-20	0158 040 5000	0158 611 0000	0168 041 0000
1/2"-20	0158 040 6000	0158 612 0000	0168 041 2000
9/18"-18	–	0158 614 0000	–
5/8"-18	–	0158 616 0000	–

* Operating pressure 3 – 4 bar.

From UNC 5/8" – 18, the tang must be removed with long nose pliers.

Manual extracting tools for HELICOIL® Classic and HELICOIL® Plus



Nominal thread Ø	Item No
d	
UNC 2-56 ... UNC 6-32	0180 300 0000
UNF 4-48 ... UNF 6-40	
UNC 8-32 ... UNC 3/8"-16	0180 301 0000
UNF 8-36 ... UNF 3/8"-24	
UNC 7/16"-14 ... UNC 5/8"-11	0180 302 0000
UNF 7/16"-20 ... UNF 9/16"-18	
UNC 3/4"-10 ... UNC 7/8"-9	0180 303 0000
UNF 5/8"-18 ... UNF 7/8"-14	
UNC 1"-8 ... UNC 1 1/8"-7	0180 304 0000
UNF 1"-14 ... UNF 1 1/8"-12	
UNC 1 1/4"-7 ... UNC 1 1/2"-6	0180 305 0000
UNF 1 1/4"-12 ... UNF 1 1/2"-12	



HELICOIL® extraction tool
UNC 2-56 to UNF 10-32

HELICOIL® extraction tool

For manual and machine disassembly of HELICOIL® thread inserts UNC 2-56 to UNF 10-32 (larger sizes on request).

Delivery scope:

- Extraction tool
- Adapter for 1/4" hexagon
- Operating instructions
- Telescoping sleeve

Deep-installed HELICOIL® thread inserts can be extracted without damaging the parent thread:

	Steel	Aluminium R _m > 200 N/mm ² **	Aluminium R _m < 200 N/mm ² **
Flush-mounted HELICOIL®	OK	OK	OK
Deep-mounted HELICOIL®	OK	OK	limited

Nominal thread Ø	Item No
UNC 2-56	0180 6636 000
UNC 3-48	0180 6646 000
UNC 4-40	0180 6656 000
UNC 6-32	0180 6676 000
UNC 8-32	0180 6686 000
UNF 10-32	0180 6697 000

The tool can be assembled using a tap wrench, ratchet or cordless screwdriver. The tool comes complete with an adapter for a cordless screwdriver.

** 1 N/mm² equals 1 MPa

Tang break-off and extraction tools for **HELICOIL®**

Tang break-off tools for **HELICOIL® Classic** and **HELICOIL® Plus**



Tang break-off mandrel



Mechanical tang break-off tool with spring tension **type TB-M**



Pneumatic tang break-off tool with thrust trigger **type TB-P**

Nominal thread Ø	Tang break-off mandrel	Type TB-M	Type TB-P pneumatic system*	
d	Item No	Item No	Item No	
BSW= British Standard Whitworth threads				
1/8"-40	0158 040 1000	0158 603 0000	on request	
3/16"-24	0158 040 2000	0158 604 0000		
1/4"-20	0158 040 3000	0158 606 0000		
5/16"-18	0158 040 4000	0158 607 0000		
3/8"-16	0158 040 4000	0158 609 0000		
7/16"-14	0158 040 5000	0158 610 0000		
1/2"-12	0158 040 6000	0158 612 0000		
9/16"-12	–	0158 612 0000		
5/8"-11	–	0158 614 0000		
11/16"-11	–	0158 616 0000		
BSF = British Standard Fine threads				
3/18"-32	0158 040 2000	0158 604 0000		on request
7/32"-28	0158 040 3000	0158 605 0000		
1/4"-26	0158 040 3000	0158 606 0000		
9/32"-26	0158 040 4000	0158 607 0000		
5/18"-22	0158 040 4000	0158 608 0000		
3/8"-20	0158 040 4000	0158 609 0000		
7/18"-18	0158 040 5000	0158 611 0000		
1/2"-16	0158 040 6000	0158 612 0000		
9/18"-16	–	0158 614 0000		
5/8"-14	–	0158 616 0000		

* Operating pressure 3–4 bar
From BSW 3/4", the tang must be removed with long nose pliers.

Manual extracting tools for **HELICOIL® Classic** and **HELICOIL® Plus**



Nominal thread Ø	Item No
d	Item No
BSW 1/8"-40 ... BSW 3/8"-16	0180 301 0000
BSF 3/16"-32 ... BSF 5/16"-22	
BSW 7/16"-14 ... BSW 5/8"-11	0180 302 0000
BSF 3/8"-20 ... BSF 5/8"-14	
BSW 11/16"-11 ... BSW 7/8"-9	0180 303 0000
BSF 11/16"-14 ... BSF 7/8"-11	
BSW 1"-8 ... BSW 1 1/8"-7	0180 304 0000
BSF 1"-10 ... BSF 1 1/8"-9	
BSW 1 1/4"-7 ... BSW 1 1/2"-6	0180 305 0000
BSF 1 1/7"-9 ... BSF 1 1/2"-8	

Tang break-off tools for **HELICOIL® Classic** and **HELICOIL® Plus**



Tang break-off mandrel



Mechanical tang break-off tool with spring tension **type TB-M**



Pneumatic tang break-off tool with thrust trigger **type TB-P**

Nominal thread Ø	Tang break-off mandrel	Type TB-M	Type TB-P pneumatic system*
d	Item No	Item No	Item No
BSP = British Standard Pipe threads · G = ISO 228/1 Pipe threads			
G 1/8"	0158 040 5000	0158 610 0000	–
BA = British Association Standard threads			
0 BA	0158 040 3000	0158 606 0000	on request
1 BA	0158 040 3000	0158 605 0000	
2 BA	0158 040 3000	0158 605 0000	
3 BA	0158 040 2000	0158 604 0000	
4 BA	0158 040 2000	0158 605 0000	
5 BA	0158 040 1000	0158 603 0000	
6 BA	0158 040 1000	0158 603 0000	

* Operating pressure 3–4 bar
From G 1/4", the tang must be removed with long nose pliers.

Manual extracting tools for **HELICOIL® Classic** and **HELICOIL® Plus**



Nominal thread Ø	Item No
d	Item No
BSP = British Standard Pipe threads · G = ISO 228/1 Pipe threads	
G 1/8"	0180 302 0000
G 1/4"	
G 3/8"	0180 303 0000
G 1/2"	
G 5/8"	0180 304 0000
G 3/4"	
G 7/8"	0180 305 0000
G 1"	
G 1 1/4"	
G 1 1/2"	
BA = British Association Standard threads	
0 BA	0180 300 0000
1 BA	
2 BA	
3 BA	
4 BA	
5 BA	
6 BA	

Böllhoff International with companies in:

Argentina
Austria
Brazil
Canada
China
Czech Republic
France
Germany
Hungary
India
Italy
Japan
Korea
Mexico
Poland
Romania
Russia
Slovakia
Spain
Switzerland
Turkey
United Kingdom
USA

Apart from these 23 countries, Böllhoff supports its international customers in other important industrial markets in close partnership with agents and dealers.

Böllhoff Group
Please find your local contact on www.boellhoff.com
or contact us under fasteningtechnology@boellhoff.com

